



User manual

Integra-W
Integra-WS

VER 2.0

FW 3.22.15 (MUX)

FW 3.22.15 (ESW)

Proprietary notice

The information presented in this guide is the property of SAF Tehnika, JSC. No part of this document may be reproduced or transmitted without proper permission from SAF Tehnika, JSC.

The specifications or information contained in this document are subject to change without notice due to continuing introduction of design improvements. If there is any conflict between this document and compliance statements, the latter will supersede this document.

SAF Tehnika, JSC has no liability for typing errors in this document or damages of any kind that result from the use of this document.

To get up to date information about accessories and their availability, please contact a sales representative.



FODU does not contain serviceable parts. Warranty will not be applicable in the event FODU has been hermetically unsealed.



SAF Tehnika, JSC is not responsible for any radio or TV interference caused by unauthorized modifications to this equipment. Such modifications could void the user's authority to operate the equipment.

This device complies with part 15 of the FCC Rules. The operation is subject to the following two conditions: (1) This device may not cause harmful interference, and (2) this device must accept any interference received, including interference that may cause undesired operation.

Note: This equipment has been tested and found to comply with the limits for a Class B digital device, pursuant to part 15 of the FCC Rules. These limits are designed to provide reasonable protection against harmful interference in a residential installation. This equipment generates, uses and can radiate radio frequency energy and, if not installed and used in accordance with the instructions, may cause harmful interference to radio communications. However, there is no guarantee that interference will not occur in a particular installation. If this equipment does cause harmful interference to radio or television reception, which can be determined by turning the equipment off and on, the user is encouraged to try to correct the interference by one or more of the following measures:

- Reorient or relocate the receiving antenna.
- Increase the separation between the equipment and receiver.
- Connect the equipment into an outlet on a circuit different from the one connected to the receiver.
- Consult the dealer or an experienced radio/TV technician for help.

This device complies with Industry Canada licence-exempt RSS standard(s). The operation is subject to the following two conditions: (1) this device may not cause interference, and (2) this device must accept any interference, including interference that may cause undesired operation of the device.

Le présent appareil est conforme aux CNR d'Industrie Canada applicables aux appareils radio exempts de licence. L'exploitation est autorisée aux deux conditions suivantes : (1) l'appareil ne doit pas produire de brouillage, et (2) l'utilisateur de l'appareil doit accepter tout brouillage radioélectrique subi, même si le brouillage est susceptible d'en compromettre le fonctionnement.

Copyright Notice

Copyright © 2022 SAF Tehnika, JSC. All rights reserved.

Contents

Chapter 1: OVERVIEW	5
Labelling	5
Microwave Radiation	6
Integra-W 24 GHz FCC & IC IDs	7
Chapter 2: INSTALLATION	8
Package contents	8
Integra-W FODU: assembling mounting bracket and installing with antenna on a pole.....	8
Disassembled mounting bracket and tools required for assembly	8
Changing polarization of Integra-W FODU and antenna	9
Assembly procedure	11
Antenna alignment.....	13
Integra-WS 15-42GHz* FODU: attaching to the antenna.....	14
Integra-WS 6-13GHz* FODU: attaching to the antenna	17
Integra-WS 6-13GHz* 2+0 & OMT interconnection	20
Connecting FO interface using fiber conduit kit.....	22
Integra-WS 6-13GHz* remote mount kit assembly	23
Integra-WS 15-42GHz* remote mount kit assembly	24
Initial setup in indoor environment.....	25
Chapter 3: WEB GUI	26
Initial configuration.....	26
Powering Integra-W/Integra-WS FODU and connecting to PC.....	26
Universal programmable PoE injector (P/N I0ATPI43)	26
System requirements.....	28
Ethernet management connection	29
Accessing Web GUI.....	30
Main page	31
Modifying basic system parameters.....	33
Parameters on Main page.....	35
Over The Air.....	36
Over The Air → Radio → Configuration.....	36
Networking	39
Networking → Ethernet → Network configuration.....	39
Networking → Ethernet → Link state propagation	40
Networking → Ethernet → Port status and configuration.....	42
Performance.....	43
Performance → Alarm → Alarm status	43
Performance → Alarm → Alarm event log	43
Performance → Alarm → Sensor configuration	46
Performance → Alarm → Alarm threshold configuration	49
Performance → Monitoring → Performance graph.....	51
Performance → Monitoring → Performance log	53
Performance → Ethernet → Ethernet switch statistics.....	54
Performance → Over The Air → Modem performance	60
Performance → Over The Air → Modem graph.....	61
System.....	66
System → FW → Firmware upgrade	66

System → Configuration → IP configuration.....	69
System → Configuration → SNMP configuration.....	70
System → Configuration → Configuration file.....	74
System → Configuration → Users configuration.....	76
System → Configuration → System configuration	78
System → Configuration → System services	81
System → Configuration → Syslog.....	84
System → Diagnostic → Loopback configuration	87
System → Diagnostic → Download troubleshooting file	88
System → Tools → License management.....	89
System → Tools → License management, steps on adding and activating a new license.....	92
System → Tools → Console.....	92
System → About → About System	94
System → About → Copyright	94
System → About → Inventory.....	95
Chapter 4: COMMAND LINE INTERFACE.....	96
Connecting to serial RS232 interface.....	96
Connecting to SSH.....	98
Connecting to Telnet	99
Chapter 5: 17/24GHz.....	100
Polarization Considerations.....	100
Radio configuration – extra fields.....	100
Setting bandwidth to 80MHz	101
Chapter 6: FUNCTIONAL DESCRIPTION	102
Information about built-in cooling fans.....	102
ACM (Adaptive Coding and Modulation)	103
ATPC (Automatic Transmit Power Control)	106
FTP directory	107
Firmware upgrade management with SNMP	108
RADIUS authentication	110
Configuration of the RADIUS server authentication.....	110
Assigning administrator rights to a RADIUS user	111
Chapter 7: TOOLS	112
Link Layer Discovery tool	112
MIB files.....	117
Chapter 8: INTERFACES.....	118
SFP port (LAN)	119
USB port.....	119
RSSI LED	120
Integra-WS RSSI LED description	121
RSSI/audio port.....	123
Grounding connection	125
Appendix A: TECHNICAL SPECIFICATION	126
ABBREVIATIONS.....	132

Chapter 1: OVERVIEW

Labelling

The label contains the following information (see samples in the picture below):

Product model name ("SAF Integra-WS-18"). The FODU model name example is:

- SAF Integra-W-38 for Integra-W 38GHz FODU,
- SAF Integra-WS-18 for Integra-WS 18GHz FODU, etc.

Product Number / Model Number (P/N or M/N) (D18WSR05LA): product/model number contains various information about the unit. Please see translation below.

Serial Number (3896301 00813): the serial number uniquely identifies the unit.

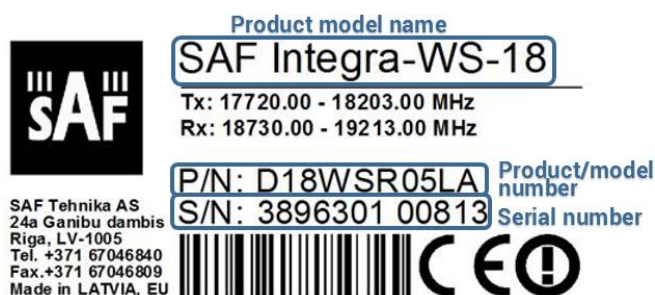

P/N or M/N translation:

"D" designates Integra series product;

"18" designates frequency band (18 GHz) of the radio;

"W" designates Integra-W product type;

"S" split-mount, without integrated antenna;

"0" - <1ft (20cm) antenna diameter and ETSI Class 3;

"1" - designates 1ft antenna diameter and ETSI Class 3;

"2" - 2ft antenna diameter and ETSI Class 3;

"3" - 3ft antenna diameter and ETSI Class 3;

"4" - 4ft antenna diameter and ETSI Class 3;

"5" - <1ft (20cm) antenna diameter and ETSI Class 4;

"6" - 1ft antenna diameter and ETSI Class 4;

"7" - 2ft antenna diameter and ETSI Class 4;

"8" - 3ft antenna diameter and ETSI Class 4;

"9" - 4ft antenna diameter and ETSI Class 4.

"R" designates Integra with full capacity licence;

"N" - 10 Mbps Basic Licence;

"L" - 100 Mbps Basic Licence;

"K" - 220 Mbps Basic Licence;

"T" - 440 Mbps Basic Licence;

"05" designates the version number of the radio;

"L" designates low side radio;

"H" - high side radio

"A" designates A subband radio;

"B" - B subband radio;

"C" - C subband radio;

"US1" - without subband radio with switch enabled.

Please note that frequency range is set from the central frequency of the first 40 MHz channel to the central frequency of the last 40 MHz channel (see the diagram below).

The frequency range of subband A low side Integra-W 18 GHz FODU:

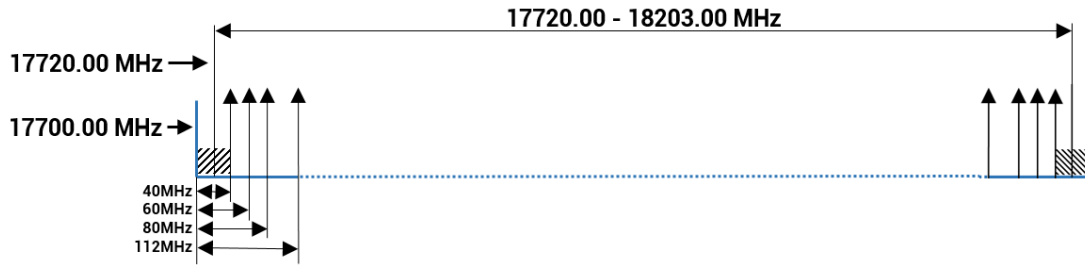

Microwave Radiation

In April 1998, ICNIRP (International Commission on Non-Ionizing Radiation Protection) published its [‘Guidelines for limiting exposure to time-varying electric, magnetic, and electromagnetic fields \(up to 300GHz\)’](#). As shown in Table 2.2-1, the guidelines (Tables 6 and 7) specify the ‘Reference levels on power density for occupational exposure and general public exposure to time-varying electric and magnetic fields (unperturbed rms values)’ between 2 and 300 GHz.

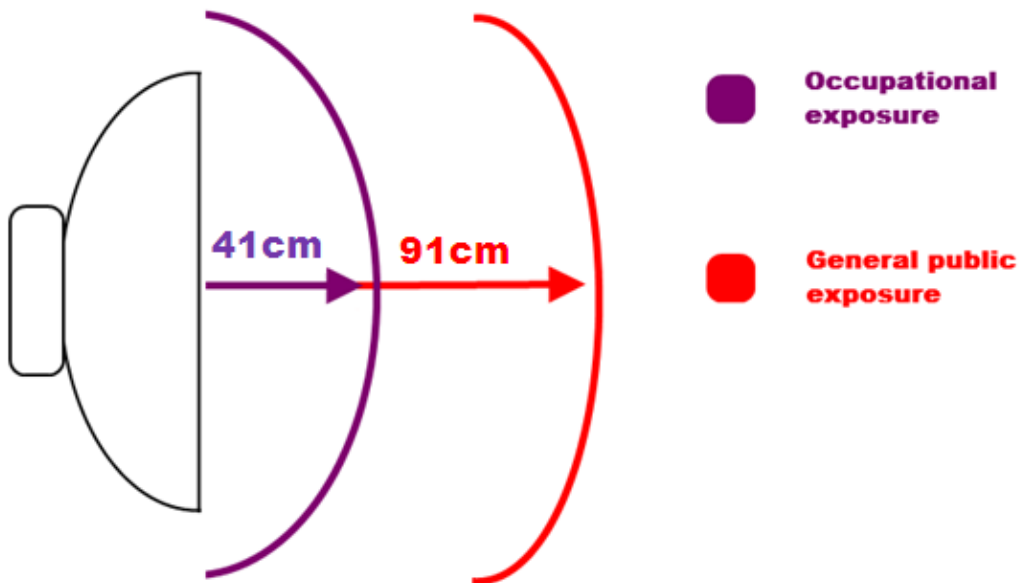

ICNIRP Reference levels within the frequency range 24 GHz

Frequency range	Exposure characteristics	Equivalent plane wave power density Seq (W/m2)	Average time period (min)
24GHz	occupational 41cm	50	$68/f^{1.05}$ (f in GHz)
	general public 91cm	10	$68/f^{1.05}$ (f in GHz)

Note: For pulsed signals, it is suggested that the peak equivalent plane wave power density, as averaged over the pulse width, does not exceed 1000 times the Seq exposure levels given in the table.

Note: Within the frequency range the 10 – 300 GHz the basic restrictions are identical to the reference levels.

Remarks on the definition of basic restrictions:

1. Power densities are to be averaged over any 20 cm² of exposed area and any 68/f^{1.05} minute period (where f is in GHz) to compensate for progressively shorter penetration depth as the frequency increases.
2. Spatial maximum power densities, averaged over 1 cm², should not exceed 20 times the values above.

Compared to the ICNIRP restrictions, FCC CFR 47 specifies the Maximum Permissible Exposure (MPE) levels for the occupational/controlled environment and general public/uncontrolled environment, as shown in the table below.

FCC MPE limits within the frequency range 1.5-100 GHz

Frequency range	Exposure characteristics	Equivalent plane wave power density Seq (W/m ²)	Average time period (min)
24GHz	occupational 41cm	50	6
	general public 91cm	10	30

Quite a few other documents specify or refer to exposure limits comparable to those given above, e.g.:

- 1999/519/EC: Council Recommendation of July 12, 1999, on the limitation of exposure of the general public to electromagnetic fields (0 Hz to 300 GHz)
- WHO: Environmental Health Criteria 137: 'Electromagnetic Fields (300 Hz to 300 GHz)'
- ANSI/IEEE C95.1, 1999: 'IEEE Standard for Safety Levels with Respect to Human Exposure to Radio Frequency Electromagnetic Fields, 3 kHz to 300 GHz'
- BRD, Bundesimmissionsschutzgesetz, 26. BImSchV Verordnung über elektromagnetische Felder
- Bundesamt für Umwelt, Wald und Landwirtschaft (BUWAL), Bern/Schweiz
Schriftenreihe Umwelt Nr. 164, Luft, Mai 1992
'Messung nichtionisierender elektromagnetischer Strahlung, 1. Teil: Frequenzbereich 100 kHz bis 300 GHz'
- DIN VDE 0848-2, Entwurf, Oktober 1991:
'Sicherheit in elektrischen, magnetischen und elektromagnetischen Feldern, Teil 2: Schutz von Personen im Frequenzbereich von 30 kHz bis 300 GHz';
- ENV 50166-2, January 1995 (withdrew in December 1999 by CENELEC)
'Human Exposure to Electromagnetic Fields (10 kHz – 300 GHz)'

Integra-W 24 GHz FCC & IC IDs

Integra-W 24 GHz:

FCC ID: W9Z-INTEGRA24W

IC ID: 8855A-INTEGRA24W

Chapter 2: **INSTALLATION**

Package contents

Integra-W	Integra-WS
- Integra-W FODU D**W1***** (0.3m), D**W2***** (0.6m)	- Integra-WS FODU D**WS*****
- Mounting bracket D0SPKR02	- Locking key for Integra-WS D0ALK002
- Locking key for Integra-W D0ALK001	- RJ-45 connector 8P shield solid FOACNR02
- Kit of replacement parts D0AZIP01	- Installation manual D0DBSRM1
- RJ-45 connector 8P shield solid FOACNR02	
- Installation manual D0DB2RM1	

Integra-W FODU: assembling mounting bracket and installing with antenna on a pole

Disassembled mounting bracket and tools required for assembly

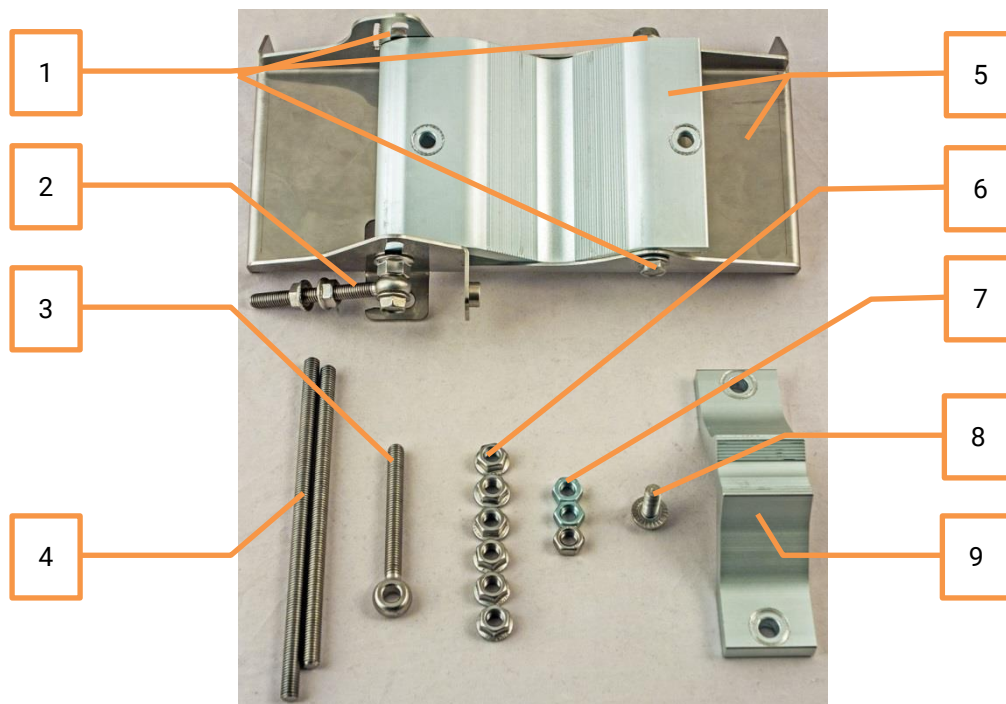

Parts of disassembled mounting bracket

#	Parts of disassembled mounting bracket
1	Three M8x1.25x16 hex flange bolts already attached to clamps for housing and pipe [5]
2	One hex flange bolt M8x1.25x30, one M10x1.5 hex flange nut and one M8x80 eye screw already attached to clamps for housing and pipe [5]
3	One M8x80 eye screw

- 4 M8x160 and M8x130 threaded rods
- 5 Clamps for housing and pipe interconnected with three M8x1.25x16 hex flange bolts [1] and an eye screw for horizontal alignment [2]
- 6 Six M8x1.25 hex flange nuts
- 7 Three M8x1.25 hex nuts
- 8 One hex flange bolt M8x1.25x20
- 9 Mounting bracket clamp

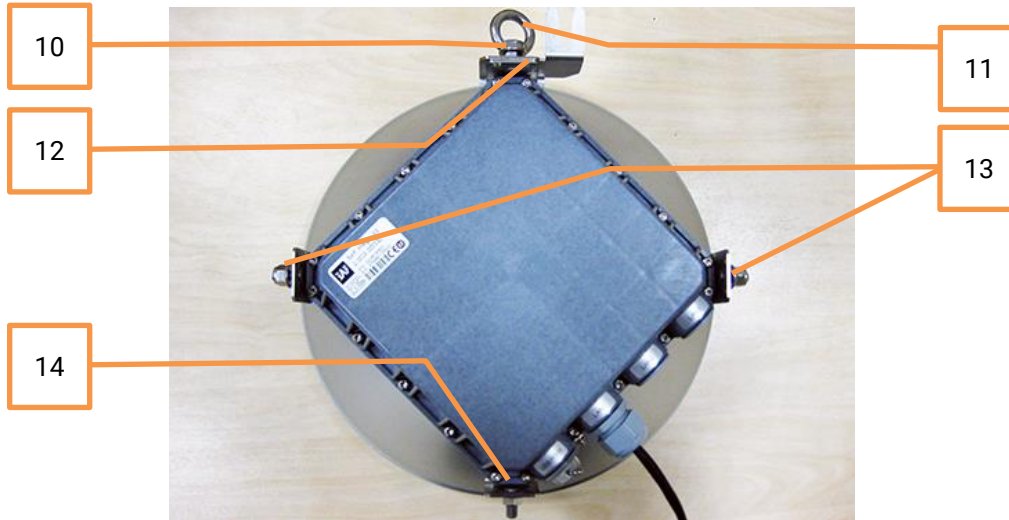

#	Parts of Integra-W FODU
10	Spacer hex flange nut
11	Lifting eye nut
12	Fixation plate
13	Side screw flange nuts
14	Grounding flange nut

Numbers of the mounting bracket and Integra-W FODU parts in next sections will be mentioned in square brackets [].

Changing polarization of Integra-W FODU and antenna

Tools required: 13mm (0.512") wrench (comes in package)



The default polarization for licensed frequency band radios is vertical.



Integra series 17/24GHz FODUs should be installed in opposite polarizations. By default, Integra series 17/24GHz FODU radios are shipped with opposite polarizations pre-installed for low and high side units.



1 Remove Integra-W FODU with an antenna from mounting bracket. Default polarization is vertical.

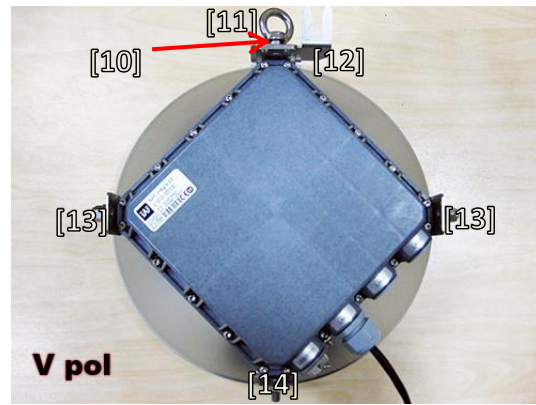

2 Using a 13mm wrench, remove indicated nuts and fixation plate [10, 11, 12, 13, 14].

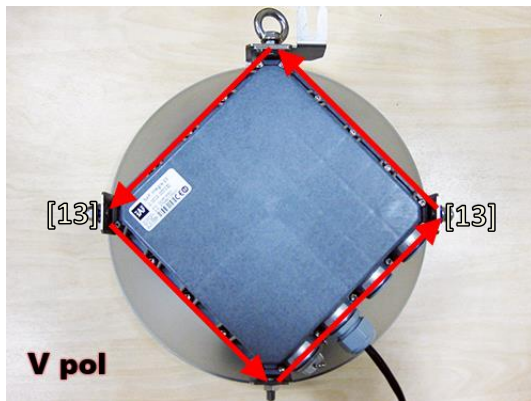

3 Removed parts must be attached back with 90-degree offset (see above). The gap between side screw flange nuts [13] and fastening angles should be 5mm.



4 View of Integra-W FODU with swapped polarization.

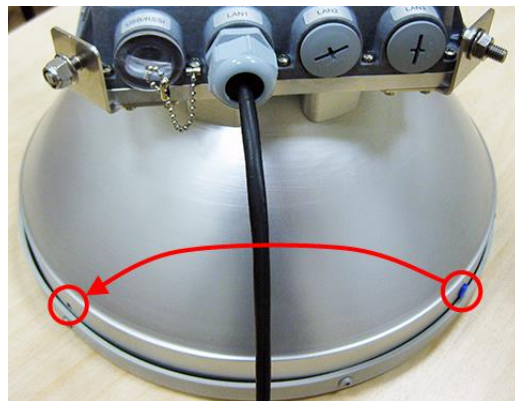

5 When polarization is changed, make sure that the drain-hole cap located at grounding flange nut is removed and inserted into the previous drain hole.

Assembly procedure

Tools required: 13mm (0.512") wrench (comes in package)

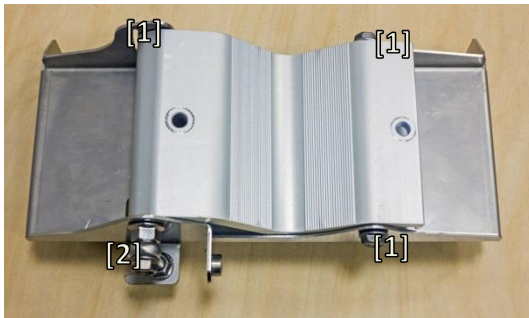

- 1** Using a 13mm wrench, slightly loosen three hex flange bolts [1] and hex flange bolt, nut and eye screw [2] interconnecting clamps for housing and pipe [5].

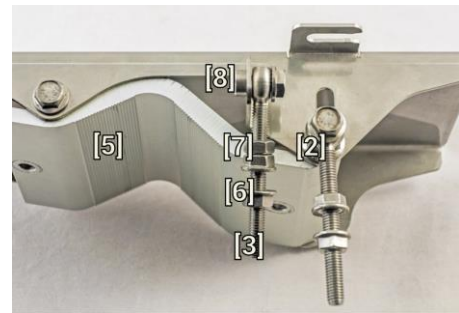

- 2** Attach vertical alignment eye screw [3] to clamps for housing and pipe [5] using hex flange bolt [8] and screw on one hex nut [7] and two hex flange nuts [6]. Make sure that both eye screws are positioned as shown in the image (turned to the back side of clamps). The gap between each two flange nuts on eye screws should be 15..20mm (0.6..0.8 in.). Do not tighten both hex flange bolts [8] and [2].



- 3** Screw on one hex flange nut [6] on each of threaded rods [4]. Note that flange nuts should be screwed on exposing approx. 20mm (0.8 in.) of threaded rods.

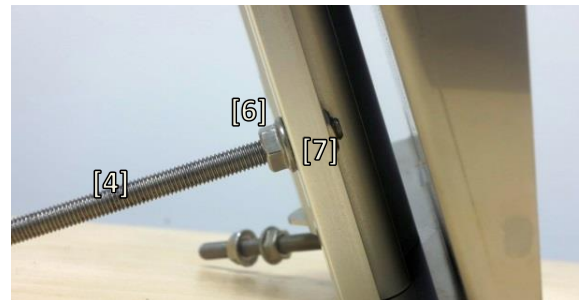

- 4** Insert both threaded bolts into two available holes of mounting clamp. Put hex nuts [7] on the other side of the clamp and screw on the threaded bolts until it is visible from the other side of the clamp no more than 2mm. Tighten hex flange nuts [6] with torsion 20..25 N·m.

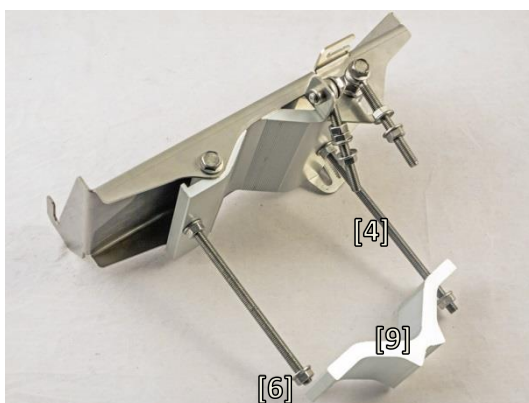

- 5** Attach mounting bracket clamp [9] on the longest threaded rod [4] as shown in the picture and afterwards screw on remaining two hex flange nuts [6] on both threaded rods. No parts should remain unassembled.

Bracket clamps in the following position support mast \varnothing 55..120mm. Reversing clamps allows support of smaller masts \varnothing 25..75mm.

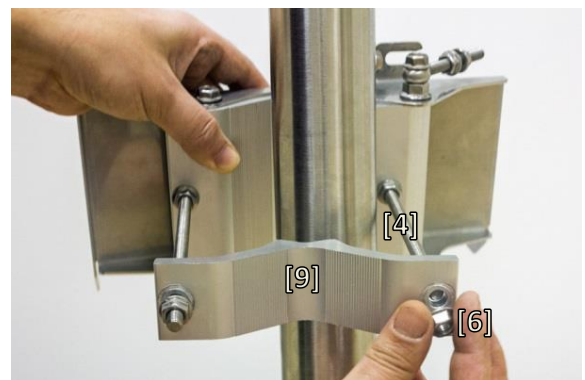

- 6** Unscrew hex flange nut [6] from the shortest threaded rod [4]. Make sure that hex flange nuts on the longest threaded rod are not too far; otherwise adjust nut's position accordingly. Put another end of mounting bracket clamp [9] on free-threaded rod and screw on hex flange nut.



7 Hex flange nuts should be evenly aligned on threaded bolts so that mounting bracket clamp [9] is tightly attached to the pipe. Tighten hex flange nuts with torsion not exceeding 20 N·m.

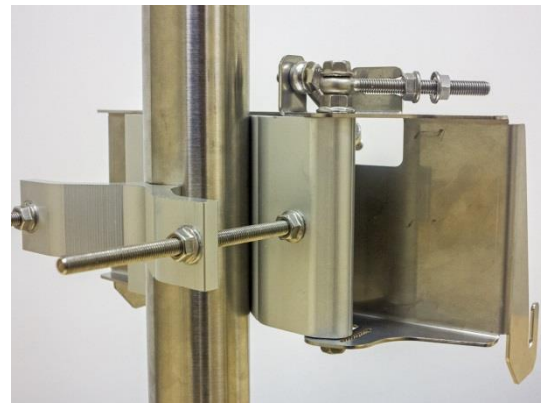

8 View of the assembled mounting bracket on the mast pole.



9 Make sure that both horizontal and vertical alignment eye screws are turned to the mast before attaching Integra-W FODU.

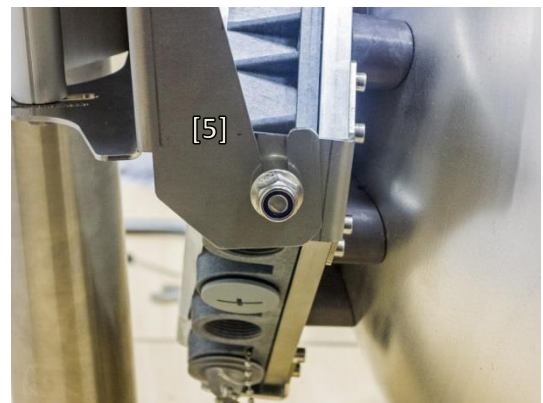

10 Attach Integra-W FODU with the antenna to the mounting bracket so that side screws fit into grooves of the housing clamp [5].

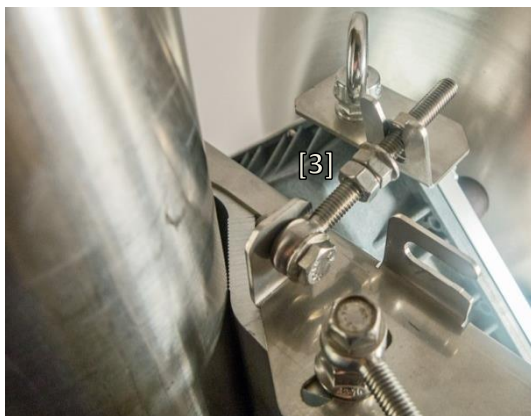

11 Connect vertical alignment eye screw [3] to the upper groove on Integra-W housing.



12 View of the assembled bracket on the mast pole with Integra-W FODU attached and secured.



It is recommended to protect the installed radio from direct sunlight.

Antenna alignment

Tools required: 13mm (0.512") wrench (comes in package)



1 Before aligning the antenna, make sure that screws marked with red dots on the right side view of the mounting bracket are loosened - hex flange nuts and bolts of azimuth and elevation eye screws, right side screw on Integra-W FODU and hex flange bolt on azimuth angle indicator.

2 Additionally loosen the following screws marked with red dots on the left side view of the mounting bracket: left side screw on Integra-W FODU and two hex flange bolts between both mounting bracket clamps for housing and pipe.



3 For initial alignment make sure that elevation is approximately at zero degrees angle by adjusting hex flange nuts [9] on vertical alignment eye screw so that Integra's housing is parallel to the bracket.



4 Adjust azimuth angle by manually moving mounting bracket in the horizontal axis. Note that all azimuth position fixing hex flange bolts, as well as horizontal alignment eye screw with flange bolt need to be loosened ensuring free movement in the horizontal axis.

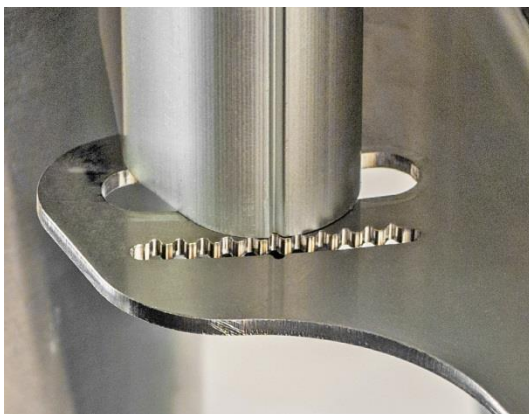

5 Each notch corresponds to one degree of azimuth angle. The half distance between notches (each lip) corresponds to 0.5 degrees.



6 Fix azimuth angle on the horizontal axis by adjusting the position of flange nuts [6] on both horizontal and vertical alignment eye screws.



7

When alignment is finished tighten screws marked with red dots on the right side view of the mounting bracket: hex flange nuts and bolts of azimuth and elevation eye screws, right side screw on Integra-W FODU and hex flange bolt on azimuth angle indicator with torsion 20..25 N·m.

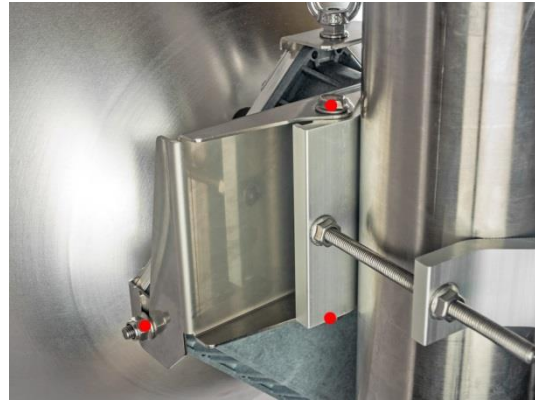

8

Additionally, tighten the following screws marked with red dots on the left side view of the mounting bracket: left side screw on Integra-W FODU and two hex flange bolts between both mounting bracket clamps for housing and pipe with torsion 20..25 N·m.

Integra-WS 15-42GHz* FODU: attaching to the antenna

Parts of Integra-WS FODU: 1 - O-ring; 2 - flange protecting sticker; 3 - wire handle; 4 - fixation clamps; 5 - grounding screws.

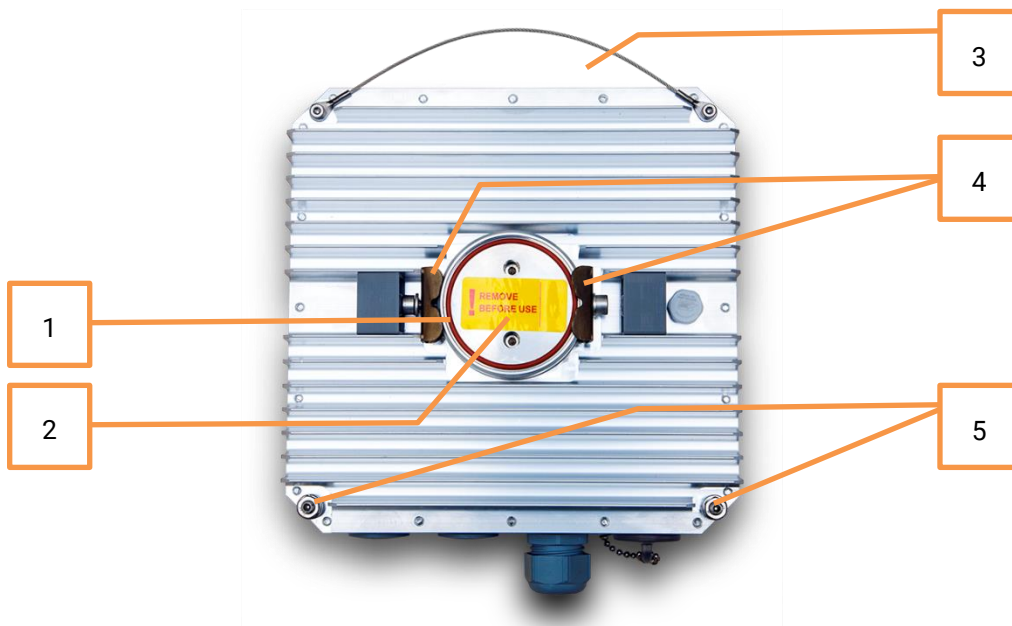

Tools required: Size 5 Allen wrench

Level (not supplied)

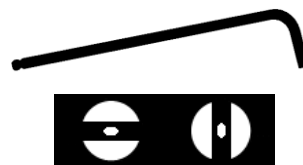

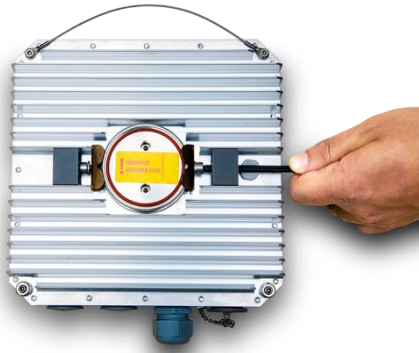

1 Using size 5 Allen wrench, loosen one clamp completely and second clamp by a half-turn.



2 Put Integra-WS on antenna adapter flange by hooking half-turn loosened clamp at the top and leaving the completely loosened clamp at the bottom. Make sure O-ring is in place and the adapter flange fits into the Integra-WS transition flange socket.

Note! The protective sticker should be removed before attaching the Integra-WS FODU to the antenna.



3 Secure the interconnection by tightening the bottom clamp (not fully). Make sure rotation of the Integra-WS is still possible.



4 Rotate Integra-WS to match the required polarization.



5 The sticker on the back lid indicates the polarization of the Integra-WS. Adjust polarization so that the interface ports are located at the lower side of the Integra-WS.



6 Verify polarization accuracy with a level, by placing it on the top edge of the Integra-WS housing



- 7 Secure the position of the Integra-WS by fully tightening both fixation clamps.

*Integra-WS 15/18/17/23/24/26/32/38/42GHz are separate FODU models



It is recommended to protect the installed radio from direct sunlight.



The default polarization for licensed frequency band radios is vertical.

Integra-WS 6-13GHz* FODU: attaching to the antenna

Integra-WS 6-13GHz* FODU features twisted polarization flange and resulting signal polarization is determined by Interface on antenna/OMT. To change signal polarization, please rotate only the antenna interface, as radio always remains in vertical position.

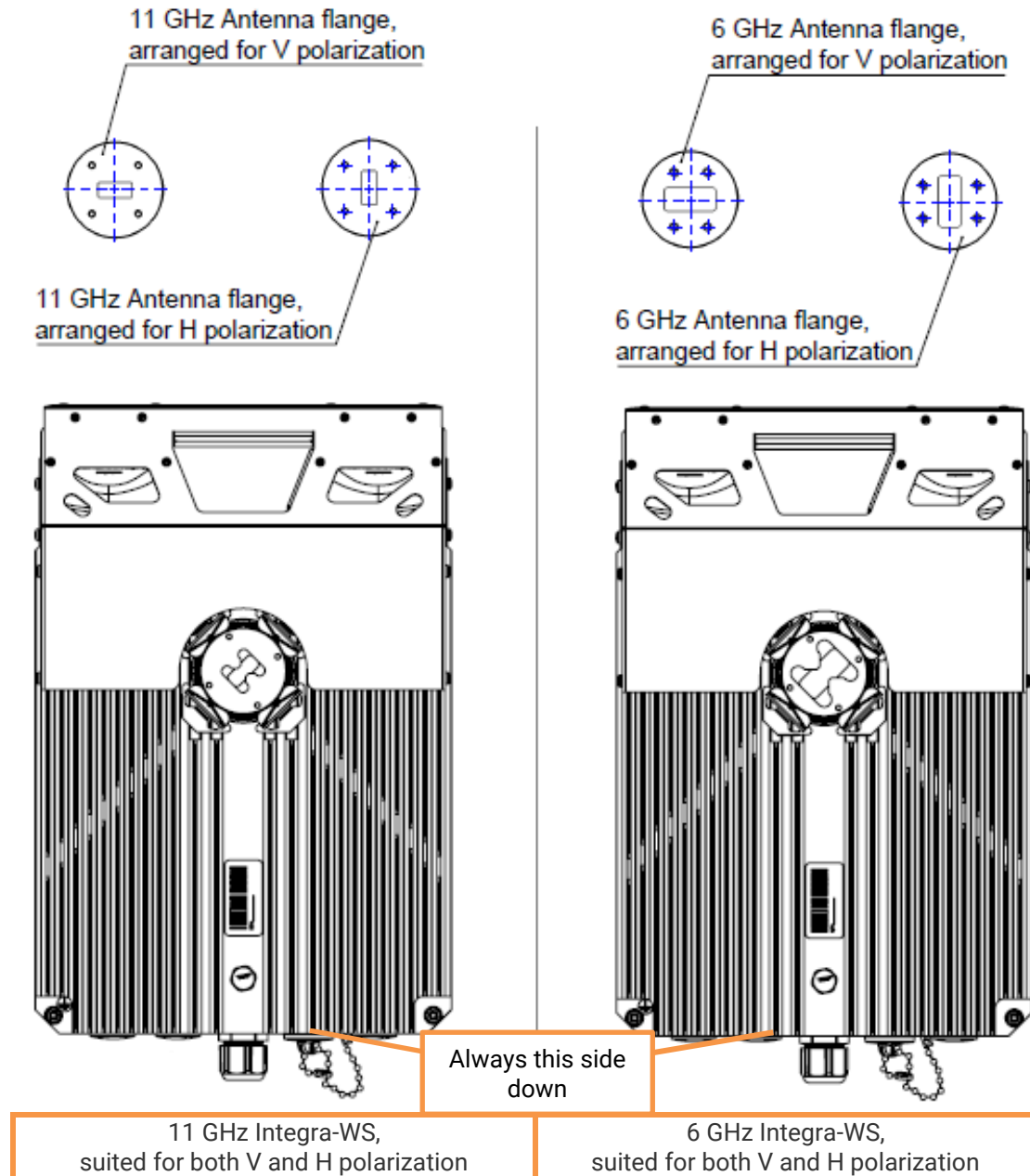

Tools required: Size 5 Allen wrench, 240mm

Level (not supplied)



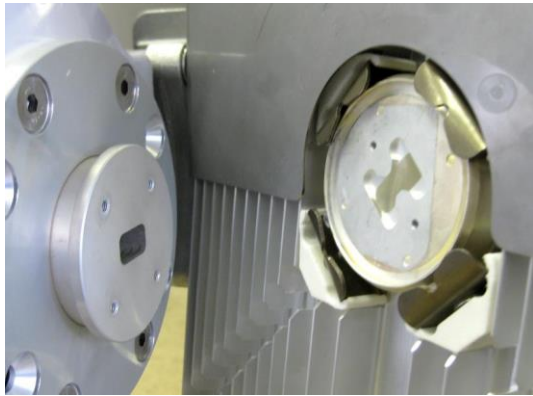

1 Integra-WS 6-13GHz* FODU features twisted polarization flange and resulting signal polarization is determined by Interface on antenna/OMT. To change signal polarization, please rotate only the antenna interface, as radio always remains in vertical position.
Example of vertical polarization interconnection.



2 Example of horizontal polarization interconnection.



3 Put Integra-WS on antenna adapter flange by hooking half-turn loosened clamp at the top and leaving the completely loosened clamp at the bottom. Make sure O-ring is in place and the adapter flange fits into the Integra-WS transition flange socket.
Note! The protective sticker should be removed before attaching the Integra-WS FODU to the antenna.



4 Tighten bottom fixation clamps.

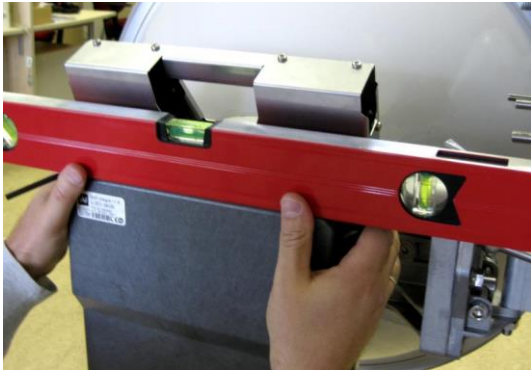

- 5 Use air level to verify that Integra-WS FODU is properly levelled. Tighten all four fixation clamps properly.



- 6 Final view of assembled Integra-WS 6-13GHz* 1+0 setup.

*Integra-WS 6U/6L/7/8/10/11/13 are separate FODU models



If any further assistance is required, please contact
techsupport@saftehnika.com

Integra-WS 6-13GHz* 2+0 & OMT interconnection



Link aggregation 2+0 for Integra-WS is available only by using external equipment (switches)!

Tools required: Size 5 Allen wrench, 240mm

10mm (0.394") wrench (not supplied)

8mm (0.315") wrench (not supplied)

Level (not supplied)

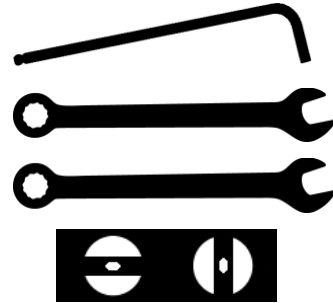

It is recommended to perform steps 1-2 on the ground.

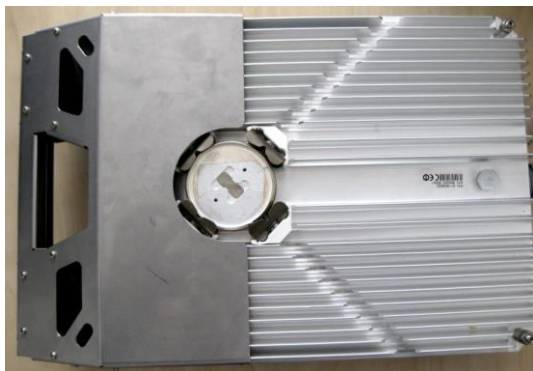

1 Prepare Integra-WS 6-13GHz* FODU by loosening both bottom clamps (should not overlap the flange plate) and tightening both upper clamps (will be used as a hook).

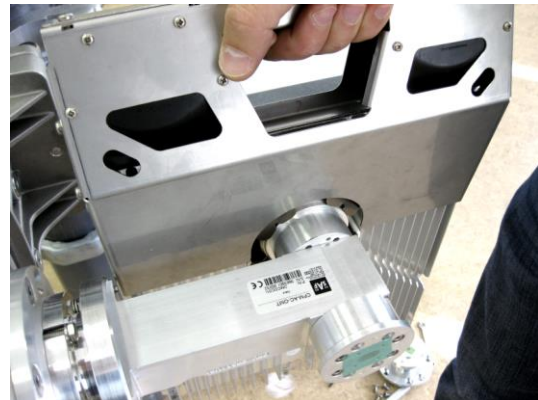

2 Attach Integra-WS 6-13GHz* FODU to the OMT using both upper clamps. Integra S 6-13GHz* FODU features twisted polarization flange and resulting signal polarization is determined by Interface on antenna/OMT. To change signal polarization, please rotate only the antenna interface, as radio always remains in vertical position.



3 Slightly tighten both bottom fixation clamps to secure FODU to the OMT.



4 Use air level to verify that FODUs are properly levelled.



- 5** Tighten all 4 Integra fixation clamps on both FODUs. When properly attached there's a gap between FODUs, OMT and antenna.



- 6** Final view of assembled Integra-WS 6-13GHz* 2+0 setup.

*Integra-WS 6U/6L/7/8/10/11/13 are separate FODU models



For connecting Integra-WS 15-42GHz to an OMT, please follow the instructions in Chapter [Integra-WS 15-42GHz* FODU: attaching to the antenna](#)



If any further assistance is required, please contact techsupport@saftehnika.com

Connecting FO interface using fiber conduit kit



1 Fiber conduit kit.



2 Unscrew the cap of the LAN-SFP port that will be used and install an SFP module.

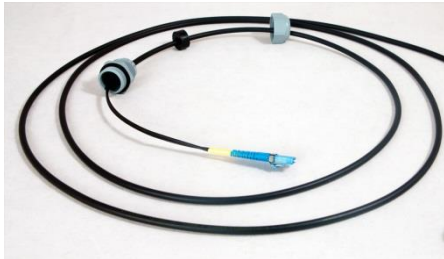

3 Disassemble conduit kit and put its parts in the following sequence (left – Integra-W direction, right – CPE direction).

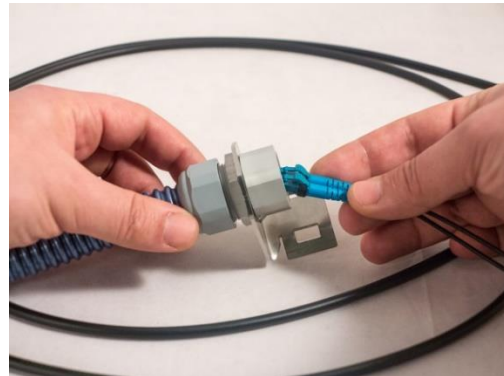

4 Push FO cable from LC connector side through the conduit.



5 Connect LC connector to SFP module.



6 Tighten parts on both ends of the conduit. Fasten another end of fiber conduit to the pole using included tie-wrap. Assembled view.

Integra-WS 6-13GHz* remote mount kit assembly

Tools required: Size 5 Allen wrench

13mm (0.512") wrench (not supplied)

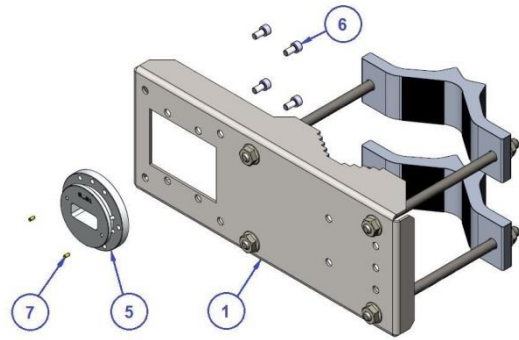
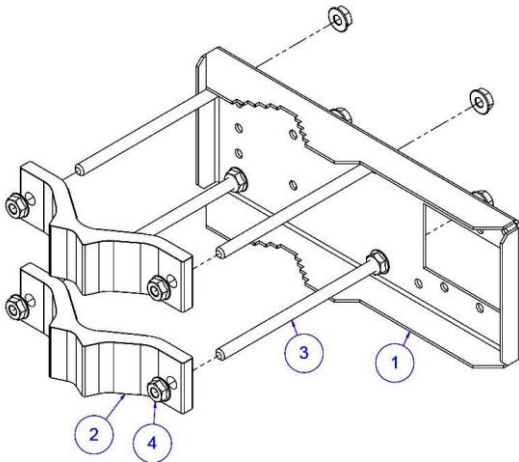

Assemble mounting bracket using 13mm wrench:

1 Screw on one hex flange nut [4] on each of four threaded rods [3]. Insert threaded rods into available holes of mounting clamp [1]. Put hex nuts [4] on the other side of the clamp and screw on the threaded rods until these are visible from another side of the clamp not more than 2mm. Tighten hex flange nuts with torsion 20..25 N·m. Attach two mounting bracket clamps [2] on threaded rods [3] as shown in the picture and afterwards screw on remaining four hex flange nuts [4] on all threaded rods.

Attach waveguide transition flange to the mounting bracket using size 5 Allen wrench:

2 Put flat side of transition flange [5] on the flat side of mounting clamp [1] as shown on the picture and screw in four socket head screws [6] from another side of the clamp. Put in two dowel pins [7] in appropriate holes of transition flange. Pins are sitting in holes very loose; therefore, perform the last action immediately before FODU installing.

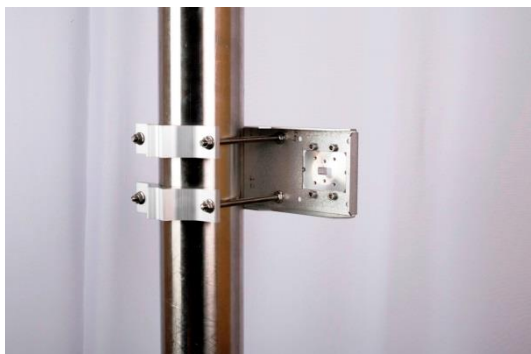

3 View of the assembled mounting bracket on thick pole mast:
Bracket clamps in following position support mast diameters 55..120 mm.



4 View of the assembled mounting bracket on thin pole mast:
Bracket clamps in reverse position support smaller mast diameters 25...75mm.

*Integra-WS 6U/6L/7/8/10/11/13 are separate FODU models

Integra-WS 15-42GHz* remote mount kit assembly

Tools required: Size 5 Allen wrench

13mm (0.512") wrench (not supplied)

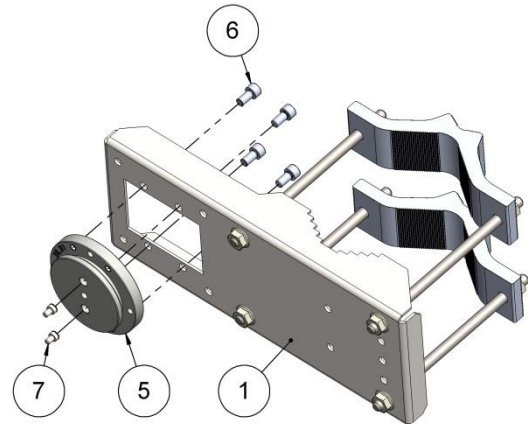
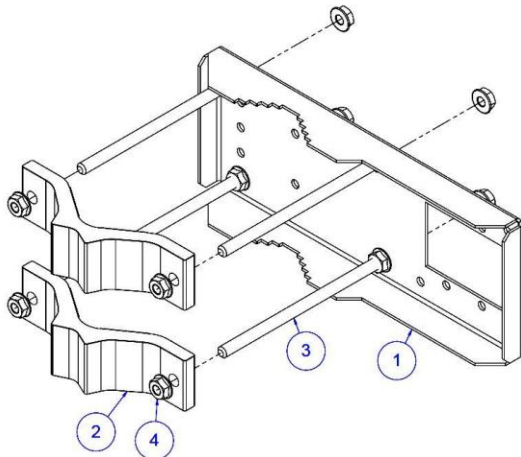

1 Assemble Mounting Bracket using 13mm wrench:
 Screw on one hex flange nut [4] on each of four threaded rods [3]. Insert threaded rods into available holes of mounting clamp [1]. Put hex nuts [4] on the other side of the clamp and screw on the threaded rods until these are visible from another side of the clamp not more than 2mm. Tighten hex flange nuts with torsion 20..25 N·m. Attach two mounting bracket clamps [2] on threaded rods [3] as shown in the picture and afterwards screw on remaining four hex flange nuts [4] on all threaded rods.

2 Attach Waveguide transition flange to the mounting bracket using Size 5 Allen wrench:
 Put flat side of transition flange [5] on the flat side of mounting clamp [1] as shown on the picture and screw in four socket head screws [6] from another side of the clamp. Two screws [7] have to be screwed into antenna flange of ODU (not shown here). Screws' heads serve as guiding pins while the ODU is attached to the transition flange [5].

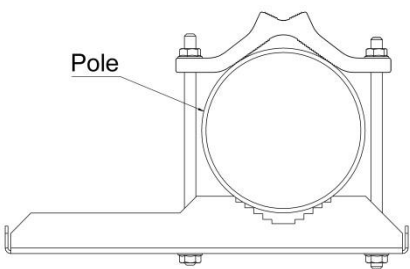
3 
 View of the assembled mounting bracket on thick pole mast:
 Bracket clamps in following position support mast diameters 55..120 mm.

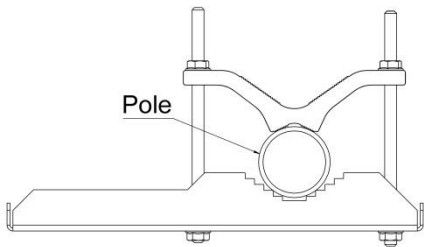
4 
 View of the assembled mounting bracket on thin pole mast:
 Bracket clamps in reverse position support smaller mast diameters 25...75mm.

*Integra-WS 15/18/17/23/24/26/32/38/42GHz are separate FODU models

Initial setup in indoor environment

Integra-WS FODUs can be interconnected using a test kit (available for purchase as optional accessory). P/N is DxxTST01, where xx – frequency band, e.g., D11TST01 for 11GHz. The exception is 17 and 24GHz radios.

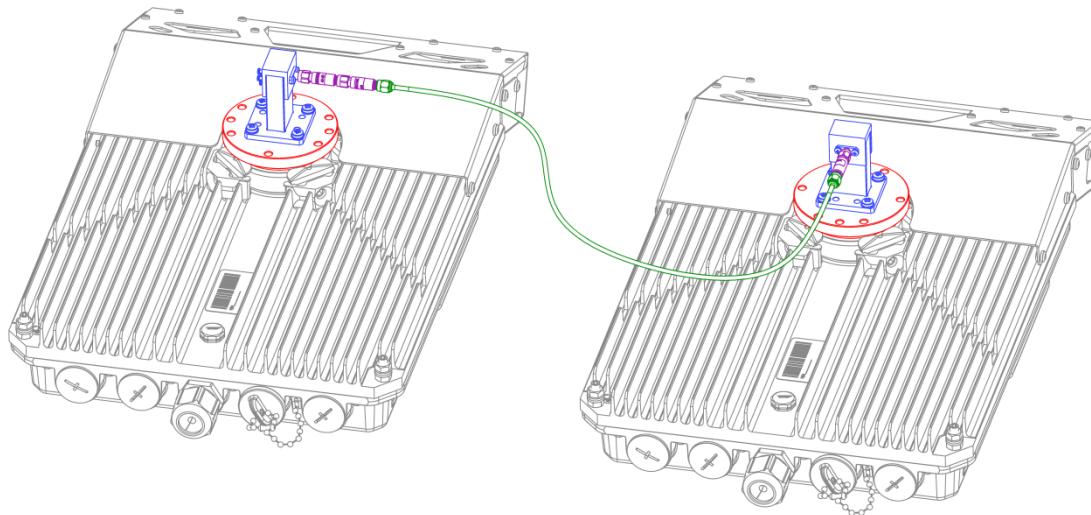

Test kit consists of **adapter flange**, **waveguide-to-coaxial adapter**, **attenuators** and **coaxial cable**.

In case of 17 and 24 GHz radios a test tube (P/N D0S17TST01 or D0S24TST01) should be used:

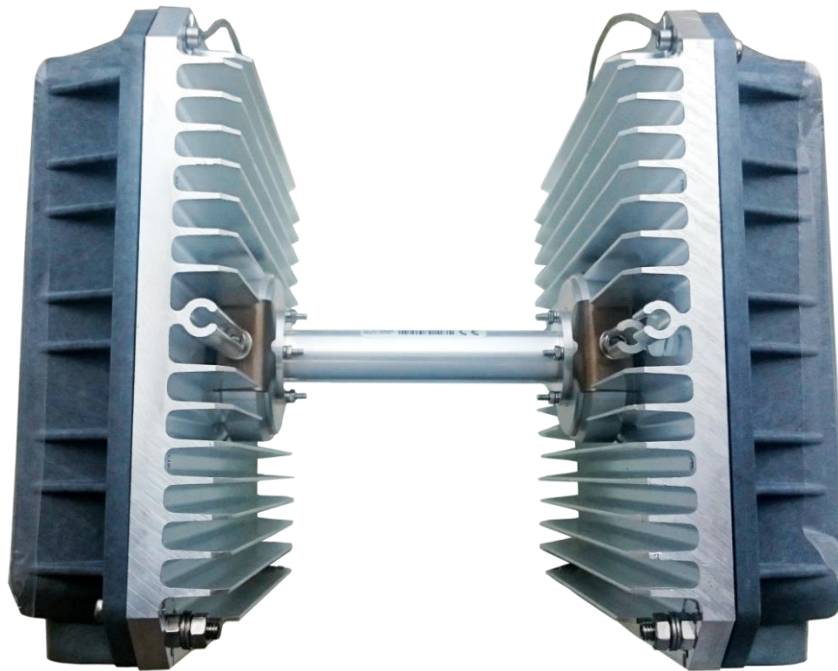

Chapter 3: WEB GUI

Initial configuration

Powering Integra-W/Integra-WS FODU and connecting to PC

Use Power over Ethernet (PoE) injector P/N I0ATPI43 with an appropriate power supply (10...57V DC). Please see the interconnection scheme below.



Use 5-10A rated type B circuit breaker in the chain between the power supply and the PoE injector for isolating each radio powered by the same PSU in case of a surge.

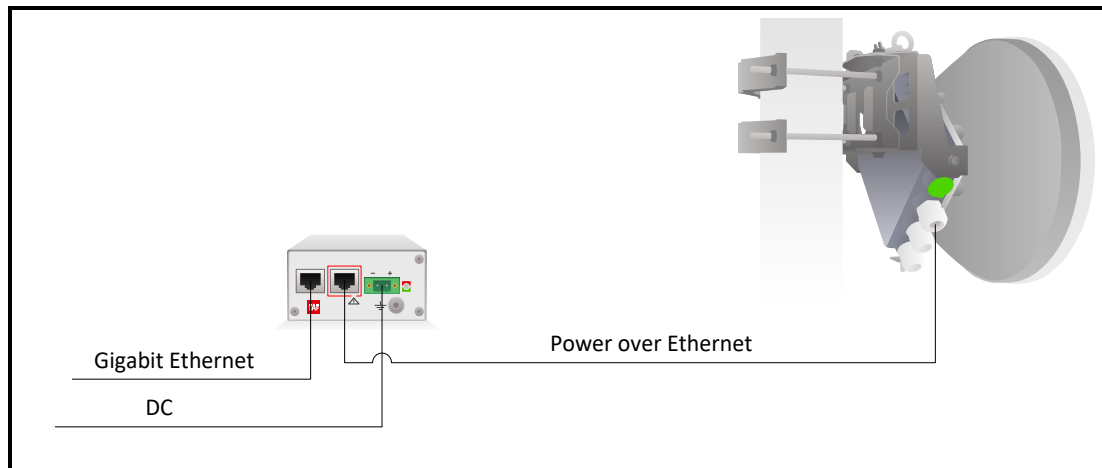

The Ethernet cable from PoE injector should be connected to the RJ-45 port on Integra-W/Integra-WS FODU (MM or LAN(TP)).



For some HW revisions, PoE may be available on data (LAN(TP)) port only.

The total length of Ethernet cables from CPE to PoE injector (DATA port) and from Integra-W/Integra-WS to PoE injector (DATA+PWR port) combined should not exceed 100m. It is recommended to use outdoor rated STP/FTP Ethernet cable Cat5e or better.

When powered RSSI LED will light up in solid green color for approx. 20s. Afterwards, RSSI LED will go out for approx. 35s and eventually start blinking indicating current Rx level. Please refer to the chapter [RSSI LED](#) for further details on blinking patterns and corresponding Rx levels.

Universal programmable PoE injector (P/N I0ATPI43)

The I0ATPI43 is an indoor Power over Ethernet injector which complies with IEEE 802.3af, LT PoE++ and Ultra PWR standards. It provides Gigabit Ethernet and DC power via a single Ethernet cable (Cat5e or better). Built-in protection conforms to the IEC 61000-4-5 standard (Class 3 up to 2kV surge).

The accepted input voltage is 10...57V DC. The output voltage is either stabilized to 57V DC or remains equal to the input voltage depending on selected operating mode.



The front panel has 3 indication LEDs. LED3 indicates the position of DIP switch S2:

1		PoE enabled and supplied to DATA+POWER port
2		Output voltage is equal to input voltage
3		Input voltage is within the range of 22-57V
		Input voltage is within the range of 10-22V

The injector has a built-in DC/DC converter, which can be switched on / off depending on customer setup. With the DC/DC converter switched on, the output voltage will be stabilized to 57V, regardless of whether the input voltage varies from 10 to 57V. It is designed to compensate the voltage loss in long cables or insufficient input voltage from power supply.

In turn, the mode with DC/DC converter switched off is suggested in setups with maximum output power needed in harsh, hot environments. The power consumed by the injector as well as the heat dissipated, will be the minimum in this mode. The power supply providing input voltage should be stabilized in this case and ensure voltage as close to 57V as possible.

The back panel has 2 switches to operate the PoE injector in different modes:

S1	S2	Mode	P(out) max	V(out)	Description
↑	↑	A	120W	57V	DC/DC converter switched on; UltraPWR
↓	↑	B ¹	90W	57V	DC/DC converter switched on; LTPoE++
↑	↓	C	120W	=V(in)	DC/DC bypass; UltraPWR
↓	↓	D	90W	=V(in)	DC/DC bypass; LTPoE++

↓ – DIP switch position DOWN, ↑ – DIP switch position UP



The position of DIP switches must be changed only when the input voltage is disconnected and PoE injector is turned off.

The PoE injector has a built-in lightning and surge protection preventing transient over-voltages from damaging radio and user's indoor equipment. Device also has an overcurrent and short circuit protection, and it is protected against reversed polarity of the input voltage.

Please be aware that proper grounding should always be used for all elements of your site setup, including the PoE injector and the powered equipment.

Electrical specification

Data rate	Up to 1000 Mb/s		
DC/DC Mode	Two modes switchable: active / disabled		
Input Voltage	10 – 57 V		
Output Voltage	Two modes switchable: 57 V / equal to the input voltage		
Max Output @ UIN 22...57 V DC	Current	802.3af mode LTPoE++ mode UltraPWR mode	

¹ Default recommended mode

Max Output Current	802.3af mode
@ UIN 10...22 V DC	
Power Connector ²	2ESDV-02P, centerline 5.08 mm / 0.2", with screw locks
Ethernet Connectors	Shielded RJ45 jacks
Data Lines	Pins (1, 2), (3, 6), (4, 5) and (7, 8)
Power Lines	+ (1, 2) and (4, 5); - (3, 6) and (7, 8)
Power Clamping Voltage	+/- 70 V
Surge protection according to CEI EN 61000-4-5	Class 3 up to 2kV surge

Mechanical specification

Ports	RJ45 - Data RJ45 - Data + Power DC - 2ESDV-02P socket with screw locks* Grounding screw
Dimensions (W/H/D):	82 mm/41 mm/154 mm
Weight	0.4 kg
Enclosure	Steel
Operating Temperature	-10°C to +50°C
Mounting	With bracket (included) 19" rack mounting shelf (P/N I0KTPI11.003) DIN-rail clip (P/N I0STPI11.001)

System requirements

To access Integra-W/Integra-WS Web GUI you will need a PC with the following Web browser:

- Google Chrome.
- Mozilla Firefox.
- Internet Explorer 8 (or above).



² - 2ESDV-02P plug with screw locks included.

Ethernet management connection

Before proceeding with initial link setup in Web GUI, you must adjust IPv4 settings of your LAN adapter to 192.168.205.0 subnet. IP address should be other than default low/high side IP addresses (192.168.205.10/192.168.205.11).

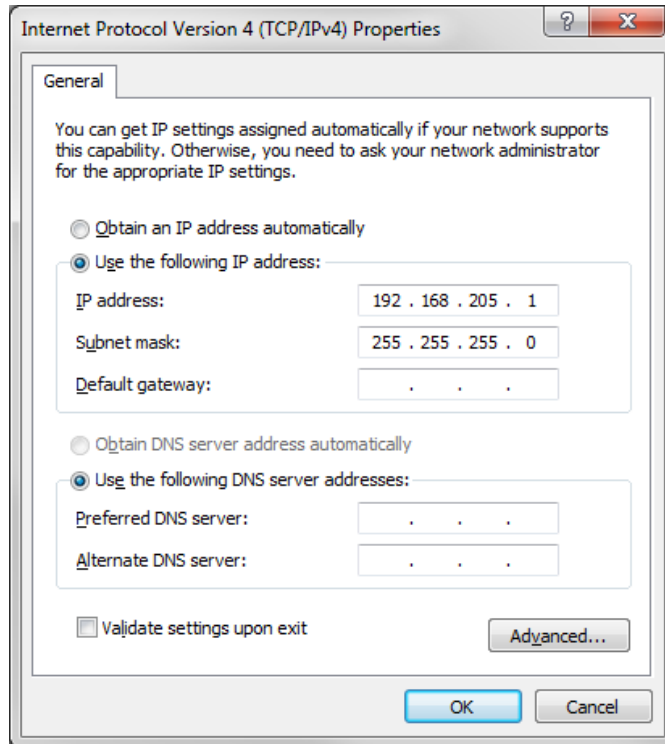

After applying these settings, you are ready to connect to Web GUI or establish SSH/Telnet connection. Refer to [Chapter 4: COMMAND LINE INTERFACE](#) for details how to connect to other CLI interfaces (serial, SSH, Telnet).

Depending on the P/N Integra-W/Integra-WS may come pre-installed with in-band management or out-band management. In case of out-band management option management access will be available only on dedicated management port (labelled "MM").

If "MM" port was used for PoE, management will be available directly on PoE injector's port, but an additional cable will be required to be installed for user data traffic. If "LAN(TP)" port was used for PoE, user data traffic will be available directly on PoE injector's port, but an additional cable will be required to be installed for management access.

Note that by default management is transmitted over the radio interface and you will have access to management of local and remote sides simultaneously. Back-to-back interconnection at remote side of the link will be required only if you have a chain of at least two Integra-W(S) links.

In case of in-band management access port labelled "MM" cannot be used for user data traffic, only for management access, while both LAN ports can be used for user data traffic and management access.

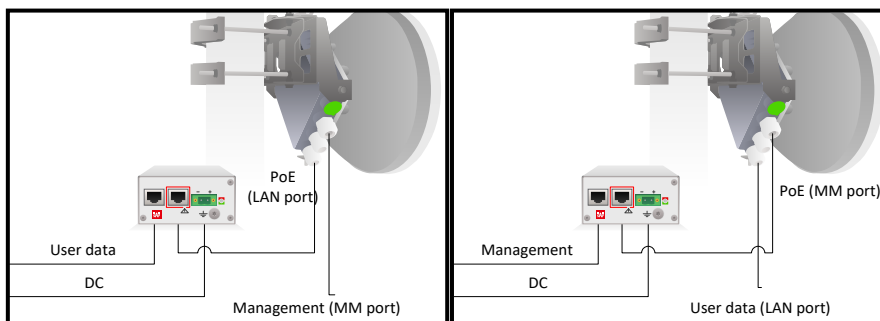

Traffic and management cable installation for out-band Integra-W/Integra-WS is show below.

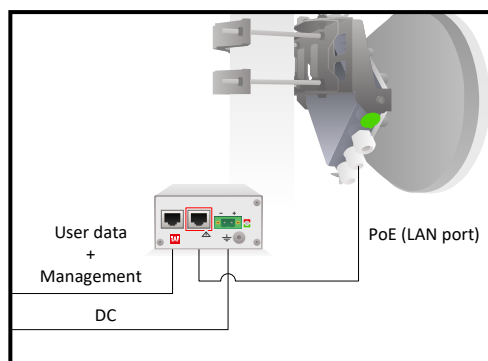

Accessing Web GUI

Launch your browser and in address field enter Integra-W/Integra-WS FODU IP address. Default IP addresses are as follows:

- 192.168.205.10 for low side Integra-W/Integra-WS FODU (P/N D*****L*)
- 192.168.205.11 for high side Integra-W/Integra-WS FODU (P/N D*****H*)



For secure connection use *https://* prefix.

- 1) Press "Enter" key.
- 2) The login screen will appear.
- 3) Enter username and password. Default credentials are as follows:
 - Username: **admin**
 - Password: **changeme**

The screenshot shows the login interface for the SAF web GUI. At the top center is the SAF logo, which consists of the letters 'SAF' in white on a red square background. Below the logo is a login form with two input fields: 'Username' and 'Password'. Below the 'Password' field is a 'Remember password' checkbox, which is currently unchecked. To the right of the checkbox is a 'Log in' button. At the bottom of the form, there is a link that says 'Switch to secure connection (HTTPS)'.

- 4) Select "Remember password" if you want the browser to remember entered login credentials.

5) Press “Log in” button.



“Switch to secure connection (HTTPS)” indicates that HTTP protocol is being used. Press the link and you will be redirected to secure HTTPS URL. Self-signed OpenSSL certificate is being used.



Minimum supported horizontal resolution is 1024px.

Main page

After login you will be automatically redirected to the Main page of Web GUI:

Integra-WS Name: SAF IP address: 192.168.100.118 Serial number: 398780100009 Uptime: 0d 00:13:10 Firmware version: 3.21.19-mux User name: admin

Main Over The Air Networking Performance System

System	Local	Remote
License remaining time	Unlimited	Unlimited

Radio	Local	Remote
Radio side	Low	High
Tx mute	Disabled	Disabled
Tx power	15 dBm	13 dBm
ATPC	Enabled	Enabled
Duplex shift	1008 MHz	1008 MHz
Tx frequency	22500 MHz	23508 MHz
Rx frequency	23508 MHz	22500 MHz
Rx level	-45 dBm	-45 dBm

Modem	Local	Remote
Bandwidth	56 MHz ETSI	56 MHz ETSI
Modem profile	32QAM	32QAM
ACM engine	Disabled	Disabled
Acquire status	Locked	Locked
Signal quality	100 %	100 %
FEC load	0 %	0 %
Current Rx modulation	32QAM	32QAM
Current Tx modulation	32QAM	32QAM
Current Rx Ethernet capacity	223.9 Mbps	223.9 Mbps
Current Tx Ethernet capacity	223.9 Mbps	223.9 Mbps

Ethernet	Local	Remote
Port	LAN (RJ-45)	MNG (RJ-45)
State	Enabled	Enabled
Status	Down	Up

System summary

Rx level: Local -45 dBm, Remote -45 dBm

Signal quality: Local 100 %, Remote 100 %

FEC load: Local 0 %, Remote 0 %

Tx polarization: Edit

Web GUI is divided into 5 sections:

1 Top panel

Shows information about Integra-W/Integra-WS FODU you are connected to including:

- Model name
- System name
- IP address
- Serial number
- Uptime
- Firmware version
- User name

2 Menu panel

Allows navigating between Main page (“Main”) and subpages of 4 sections:

- Over the air (Radio/modem (NP) configuration)
- Networking (Ethernet configuration)
- Performance
- System

3 Main Web GUI window

By default, Main page (“Main”) is shown. Contents will change according to menu panel selection.

4 MODIFY / SAVE / LOGOUT

Allows modifying parameters in the main window. If none can be modified, MODIFY button appears inactive. After modification SAVE button becomes active and indicates a number of unsaved changes as well as their type (when moving the cursor over the button). LOGOUT button will logout from the current session.

5 System summary

Shows one to four (default value – three) selected parameters of the local and remote systems, as well as Tx polarization (as read from the internal accelerometer). Tx polarization is not shown for 6-13GHz models. If radios are placed on the table with flange facing up or down, Tx polarization indication will be shown accordingly with antenna facing up or down.



Values appear in **red color** in case of exceeding [alarm threshold values](#) or in case of a warning (e.g., if loopback is active).

Values appear in **orange color** in case [alarm threshold values](#) were exceeded during last 15 seconds.

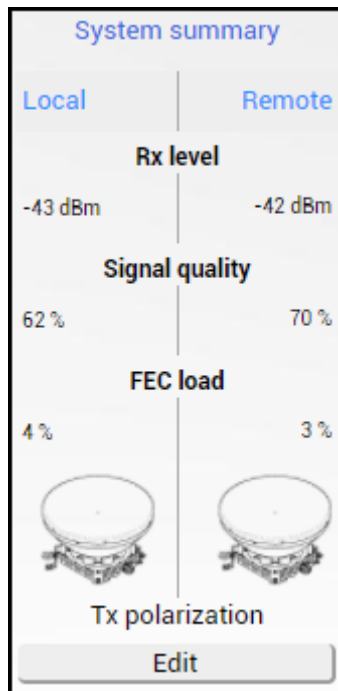

Modifying basic system parameters

In order to proceed with initial configuration, press MODIFY button and entry fields will appear for adjustable values:

Main		
System	Local	Remote
License remaining time	Unlimited	Unlimited
Radio	Local	Remote
Radio side	Low	High
Tx mute	Disabled	Disabled
Tx power (2 .. 17 dBm for 1024QAM)	15 dBm	15 dBm
ATPC	Enabled	Enabled
Duplex shift	1008 MHz	1008 MHz
Tx frequency (22056.00 .. 22540.00 MHz)	22298.00 MHz	23306 MHz
Rx frequency	23306 MHz	22298 MHz
Rx level	-43 dBm	-42 dBm
Modem	Local	Remote
Filter	<input checked="" type="radio"/> All <input type="radio"/> FCC <input type="radio"/> ETSI	
Bandwidth	40 MHz FCC 50 MHz FCC 56 MHz ETSI 60 MHz FCC 80 MHz FCC 100 MHz FCC 112 MHz ETSI	
Modem profile	64QAM ACM 128QAM 128QAM ACM 256QAM 256QAM ACM 512QAM 512QAM ACM 1024QAM 1024QAM ACM	
ACMB engine	Enabled	Enabled
Acquire status	Locked	Locked
Signal quality	63 %	70 %
FEC load	4 %	4 %
Current Rx modulation	1024QAM	1024QAM
Current Tx modulation	1024QAM	1024QAM
Current Rx Ethernet capacity	882.6 Mbps	882.6 Mbps
Current Tx Ethernet capacity	882.6 Mbps	882.6 Mbps
Ethernet	Local	Remote
Port	LAN (RJ-45)	MNG (RJ-45)
State	<input checked="" type="checkbox"/> Enable	<input checked="" type="checkbox"/> Enable
Status	Down	Up

Rollback on Execute configuration

1 Tx power

The available range depends on the radio model and selected modulation. The actual range will be indicated in the brackets.

2 Tx frequency

The available range depends on the frequency band, subband, radio side, and channel bandwidth selected. The actual range will be indicated in the brackets.

Tx frequency range indicates the range of central frequencies for the configured channel bandwidth.

The default frequency range (indicated on the label) is defined for 40MHz channel bandwidth.

3 Filter

Allows choosing whether only FCC, ETSI or both channel bandwidth options are visible in "Bandwidth" selection field.

4 Bandwidth

Allows choosing between available channel bandwidth, bandwidth standard (ETSI or FCC).

5 Modem profile

Allows choosing between available modulations for selected channel bandwidth.

ACM stands for Adaptive Coding and Modulation and enables adaptive modulation change according to Signal Quality value. Modulation indicates maximum modulation, while the minimum is 4QAM.

6 State

Allows enabling/disabling each of available ports. You can switch LAN port between electrical and SFP interfaces in [Networking→Ethernet→Port status and configuration](#) only in out-band firmware version.

7 Execute

By pressing „*Execute configuration*“ changes made to the corresponding section apply only to the local side Integra-W/Integra-WS. If „*Rollback on*“ is selected, the configuration will be reverted in case erroneous configuration changes are applied.



Rollback triggers when configuration changes applied interrupt management connectivity. For this reason, rollback will not work if the remote side of the link is not reachable.

Pressing „*Execute for both*“ applies changes made to the corresponding section both for local and remote side Integra-W/Integra-WS FODUs.

Parameters on Main page

Main			
System		Local	Remote
License remaining time	1	Unlimited	Unlimited
Radio		Local	Remote
Radio side	2	High	Low
Tx mute	3	Disabled	Disabled
Tx power	4	15 dBm	15 dBm
ATPC	5	Enabled	Enabled
Duplex shift	6	1008 MHz	1008 MHz
Tx frequency	7	23306 MHz	22298 MHz
Rx frequency	8	22298 MHz	23306 MHz
Rx level	9	-42 dBm	-44 dBm
Modem		Local	Remote
Bandwidth	10	112 MHz ETSI	112 MHz ETSI
Modem profile	11	1024QAM ACM	1024QAM ACM
ACM engine	12	Enabled	Enabled
Acquire status	13	Locked	Locked
Signal quality	14	71 %	65 %
FEC load	15	2 %	4 %
Current Rx modulation	16	1024QAM	1024QAM
Current Tx modulation	17	1024QAM	1024QAM
Current Rx Ethernet capacity	18	882.6 Mbps	882.6 Mbps
Current Tx Ethernet capacity	19	882.6 Mbps	882.6 Mbps
Ethernet			
Port	20	LAN (SFP)	MNG (RJ-45)
State	21	Enabled	Enabled
Status	22	Down	Down

- 1) **License remaining time** – shows the amount of time (in seconds) remaining for active time-limited license; in case of unlimited time license, “Unlimited” is being shown.
When the license expires, modulation will drop to “4QAM Limited”, link capacity will drop to 256 Kbps, and you will see a warning.
- 2) **Radio side** – shows the radio side of the local and remote Integra-W.
- 3) **Tx mute** – Tx shows if the transmitter is currently muted (“Enabled”) or active (“Disabled”).
- 4) **TX power** – shows current transmitter power in dBm.
- 5) **ATPC** – shows if ATPC is enabled or disabled.
- 6) **Duplex shift** – shows the margin between the transmitting and receiving frequencies.
- 7) **Tx frequency** – shows the transmitting frequency.
- 8) **Rx frequency** – shows the receiving frequency.
- 9) **Rx level** – shows the current level of the received signal. It must not differ significantly from the previously calculated value.
- 10) **Bandwidth** – shows the width of currently utilized bandwidth in MHz.
- 11) **Modem profile** – Indicates currently configured modulation.
An option with “ACM” (please refer to the chapter [ACM \(Adaptive Coding and Modulation\)](#) for further details) enables adaptive modulation change according to Signal Quality value. Modulation indicates maximum modulation, while the minimum is 4QAM.
- 12) **ACM engine** – shows the status of ACM engine.
- 13) **Acquire status** – indicates the acquired status of the modem. During normal operation “Locked” will be shown.
- 14) **Signal quality** – shows an estimation of SNR expressed as a percentage.

- 15) **FEC load** – shows Forward Error Correction decoder load expressed as a percentage.
- 16) **Current Rx modulation** – current received signal modulation.
- 17) **Current Tx modulation** – current transmitted signal modulation.
- 18) **Current Rx Ethernet capacity** – ingress capacity of the WAN port, depends on current Rx modulation and bandwidth.
- 19) **Current Tx Ethernet capacity** – egress capacity of the WAN port, depends on current Tx modulation and bandwidth.
- 20) **Port** – Name and interface type of the Ethernet port, RJ-45 or SFP/SFP+.
- 21) **State** – Ethernet port state – Enabled or Disabled. An exclamation mark designates restricted state of the port. Move the mouse pointer over the icon to see the explanation.
- 22) **Status** – Ethernet port status, up or down (if the port is enabled).

Over The Air

Over The Air → Radio → Configuration

The Radio configuration page is available in the menu (Over The Air → Radio → Configuration). Refer to the chapter [Radio configuration – extra fields](#) for description of the extra fields of the 17/24 GHz Integra-W/Integra-WS FODUs.

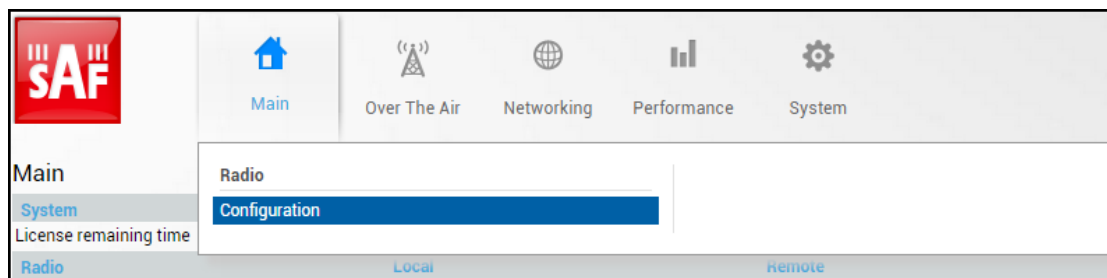

Status mode

Over The Air / Radio configuration		
Tx power (2 .. 17 dBm for 1024QAM)	1	15 dBm
Tx frequency (23064.00 .. 23548.00 MHz)	2	23306 MHz
Tx mute [>= 10 sec]	3	Disabled
RSSI Audio	4	Enabled
RSSI LED	5	Enabled
RSSI LED mode	6	1
ATPC	7	Enabled
ATPC update period (1 .. 5 sec)	8	1 sec
Tx power correction	9	0 dB
Rx (remote) level range (-75..-40 dBm)	10	-50 dBm -40 dBm
Difference between Rx min and Rx max must be at least 3 dBm		
Bandwidth	12	112 MHz ETSI
Modem profile	13	1024QAM ACM

Press  **MODIFY** button.

Modify mode

Over The Air / Radio configuration			
Tx power (2 .. 17 dBm for 1024QAM)	1	<input type="text" value="15"/>	dBm
Tx frequency (23064.00 .. 23548.00 MHz)	2	<input type="text" value="23306.00"/>	MHz
Tx mute [>= 10 sec]	3	<input type="checkbox"/> Tx mute	<input type="text"/> sec
RSSI Audio	4	<input checked="" type="checkbox"/> Enable	
RSSI LED	5	<input checked="" type="checkbox"/> Enable	
RSSI LED mode	6	<input type="text" value="1"/>	
ATPC	7	<input checked="" type="checkbox"/> Enable	
ATPC update period (1 .. 5 sec)	8	<input type="text" value="1"/>	sec
Tx power correction	9	<input type="text" value="0"/>	dB
Rx (remote) level range (-75..-40 dBm)	10	<input type="text" value="-50"/>	dBm <input type="text" value="-40"/> dBm
Difference between Rx min and Rx max must be at least 3 dBm			
Filter	11	<input checked="" type="radio"/> All <input type="radio"/> FCC <input type="radio"/> ETSI	
Bandwidth	12	40 MHz FCC 50 MHz FCC 56 MHz ETSI 60 MHz FCC 80 MHz FCC 100 MHz FCC 112 MHz ETSI	
Modem profile	13	64QAM ACM 128QAM 128QAM ACM 256QAM 256QAM ACM 512QAM 512QAM ACM 1024QAM 1024QAM ACM	
		14	Rollback on <input type="checkbox"/> <input type="button" value="Execute configuration"/> <input type="button" value="Execute for both"/>

- 1) **Tx power** – Indicates current Tx (transmit) power value (status mode); allows specifying Tx power value (modify mode). Available range depends on radio model and selected modulation. Actual range will be indicated in the brackets. ⚠ sign indicates that Tx power value was adjusted by ATPC. Move mouse over the sign for further details.
- 2) **Tx frequency** – Indicates current Tx (transmit) frequency (status mode); allows specifying Tx frequency (modify mode). Available range depends on the frequency band, subband, radio side and channel bandwidth selected. Actual range will be indicated in the brackets.

Tx frequency range indicates the range of central frequencies for configured channel bandwidth.
Default frequency range (indicated on the label) is defined for 40MHz channel bandwidth.
- 3) **Tx mute [>=10 sec]** – Indicates whether Tx mute is enabled or disabled (status mode); allows muting transmitter to the limited time interval in seconds (modify mode). The minimum value is 10 seconds. Note that transmitter will be muted only if the valid value in seconds is entered.
- 4) **RSSI Audio** – Indicates whether RSSI audio is enabled or disabled (status mode); allows disabling or enabling RSSI audio (modify mode). RSSI audio is available using 3.5mm jack beside USB port. By default, RSSI Audio is disabled. Please refer to [RSSI/audio port](#) description for further details.

- 5) **RSSI LED** – Indicates whether RSSI LED is enabled or disabled (status mode); allows disabling or enabling RSSI LED operation (modify mode). By default, RSSI LED is enabled. Please refer to [RSSI LED section](#) for further details.
- 6) **RSSI LED mode** – Indicates which RSSI LED mode is active (status mode); allows selecting RSSI LED operation mode (modify mode). By default, Mode 1 is enabled. Please refer to [RSSI LED section](#) for further details.
- 7) **ATPC** – Indicates whether ATPC (Automatic Transmit Power Control) is enabled (status mode); allows enabling/disabling ATPC (modify mode). By default, this feature is disabled. Please refer to the [ATPC \(Automatic Transmit Power Control\)](#) description for further details.
- 8) **ATPC update period (1..5 sec)** – Indicates ATPC update period (status mode); allows defining the period in seconds with which ATPC parameters are being updated (modify mode). By default, the update period is 5 seconds. The range is 1..5 seconds. Please refer to the [ATPC \(Automatic Transmit Power Control\)](#) description for further details.
- 9) **Rx (remote) level range (-75..-40 dBm)** – Indicates minimum and maximum Rx level of remote side Integra-W/Integra-WS for ATPC operation (status mode); allows defining the minimum and maximum Rx level of remote side Integra-W/Integra-WS (modify mode). There should be at least 3dB difference between min and max values. ATPC Tx power correction will be performed only in case of exceeding these thresholds. Please refer to the [ATPC \(Automatic Transmit Power Control\)](#) description for further details.



Minimum Rx level threshold should be set at least 10dB above sensitivity threshold in order to avoid ACM/ATPC switching loops.



ATPC operates only when ACM is at maximum modulation (if ACM is enabled).

- 10) **Filter** – Allows choosing whether only FCC, ETSI or both channel bandwidth options are visible in “Bandwidth” selection field. Controls are available in modify mode only.
- 11) **Bandwidth** – Indicates currently configured channel bandwidth (status mode); allows choosing between available channel bandwidth options along with an indication of maximum modulation, as well as according to the standard of channel bandwidth – ETSI or FCC (modify mode).
- 12) **Modem profile** – Indicates currently configured modulation (status mode); allows choosing between available modulations for selected channel bandwidth (modify mode).

An option with “ACM” (please refer to the chapter [ACM \(Adaptive Coding and Modulation\)](#) for further details) enables adaptive modulation change according to Signal Quality value. Modulation indicates maximum modulation, while the minimum is 4QAM.

- 13) By pressing „Execute configuration” changes made to the corresponding section apply only to the local side Integra-W/Integra-WS. If „Rollback on” is selected, the configuration will be reverted in case erroneous configuration changes are applied.

Pressing „Execute for both” applies changes made to the corresponding section both for local and remote side Integra-W/Integra-WS FODUs.

CLI commands ([Chapter 4: COMMAND LINE INTERFACE](#))

radio [status]	Use to show radio configuration status.
radio power <Tx power>	Use to set Tx power in dBm.
radio frequency <frequency>	Use to set Tx frequency in kHz.

radio rssi-led {disable enable [mode {1 2 3}]}	Use to enable or disable RSSI LED operation.
radio rssi-led enable mode {1 2 3} polarization <seconds>	Use to enable the red RSSI LED's operation for n seconds. Its main purpose is indication of polarization alignment accuracy +/- 3deg. Functionality may not be available in older HW revisions.
radio tx-mute {<time> disable}	Use to mute transmitter on specific time in seconds or unmute.
radio factory	Use to reset radio settings to factory defaults – Tx power will be disabled and frequencies set to factory defaults.
radio upgrade <firmware>	Use to upgrade radio firmware version. Firmware file must be located in FTP directory.
radio version	Use to check radio software version
radio atpc [status]	Use to check the status of ATPC (Automatic Transmit Power Control).
radio atpc state {enable disable}	Use to enable/disable ATPC.
radio atpc delay <1..5>	Use to define ATPC update period.
radio atpc rx_level <-75..-40> <-72..-40>	Use to define ATPC remote Rx level min and max thresholds.
modem	Use to show modem configuration status.
modem configuration set <bandwidth> <min_mod> <max_mod>	Use to set modem configuration – bandwidth, minimum and maximum modulation.
modem configuration set factory	Use to reset modem settings to factory defaults – bandwidth and modulation will be reset to a minimum.
modem loopback {digital <seconds> none}	Use to enable modem loopback for n seconds or disable it.
modem allowed	Use to check the list of available modem configurations.
modem allowed show <bandwidth> <mod>	Use to check capacity at the particular bandwidth and modulation.

Networking

Networking → Ethernet → Network configuration³

Status mode

Networking / Network configuration	
Data port interface configuration	
Data port priority	1 RJ-45
Frame size configuration	
Jumbo frame support	2 Enabled

Press  **MODIFY** button.

³ Available only in out-band firmware version (3.xx.x-mux).

Modify mode

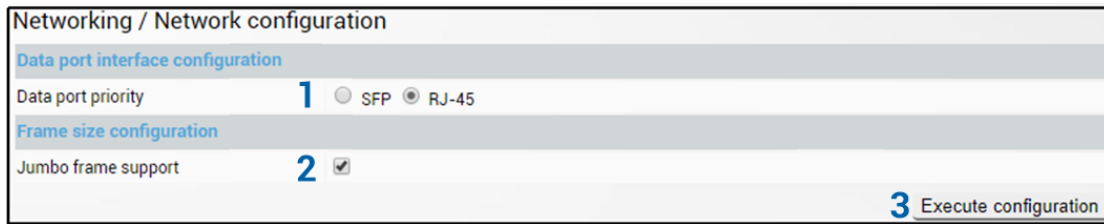

- 1) **Data port priority** – Indicates current priority interface of LAN (data) port – SFP or electrical RJ-45 (status mode); allows setting priority interface for LAN (data) port – SFP or electrical RJ-45 (modify mode). Note that only single LAN port can be active, the other one is ignored. By default, priority is set to electrical RJ-45 interface.



Priority setting means that if both interfaces are linked, only the priority interface will be used. This way redundancy can be set up – if the prioritized interface goes down, the secondary one will take over.



Note that the active interface is indicated in “Main status” and “Port status and configuration” pages.

- 2) **Jumbo frame support** – Indicates whether jumbo frame support is enabled (status mode); allows enabling or disabling jumbo frame support (modify mode). By default, jumbo frame support (up to 9600B) is enabled. When disabled, maximum supported frame size is 1522B.
- 3) By pressing „Execute configuration” changes made to the corresponding section apply only to the local side Integra-W/Integra-WS.

CLI commands (Chapter 4: COMMAND LINE INTERFACE)

network port set LAN jumbo {enable disable}	Use to enable or disable jumbo frame support on LAN port.
network port set LAN interf-prio [{RJ-45 sfp}]	Use to show/set active LAN port – electrical RJ-45 or SFP.

Networking → Ethernet → Link state propagation⁴

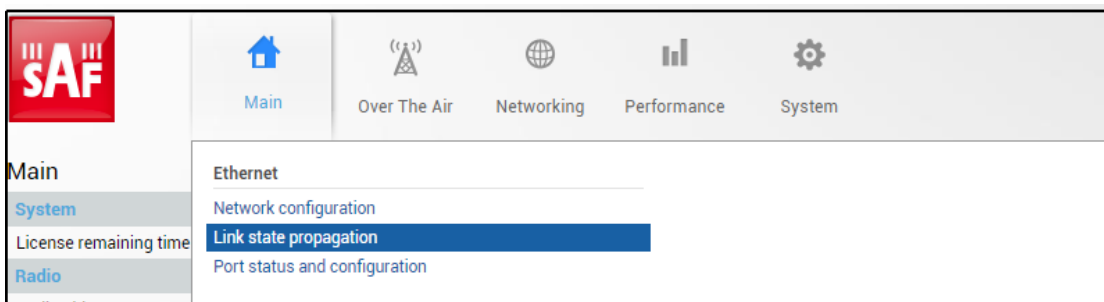

⁴ Available only in out-band firmware version (3.xx.x-mux).

Status mode

Networking / Link state propagation		
State	1	Disabled
LAN auto recovery*	2	0 sec
SyncLoss keepalive timeout	3	3 sec
LSP startup timeout	4	60 sec
WAN state	5	UP
Port state	6	UP
SNMP traps	7	Disabled

*LAN port will recover after synchronization reestablishment, if 0 sec. has been set!

Press  **MODIFY** button.

Modify mode

Networking / Link state propagation		
State	1	<input type="checkbox"/> Enable
LAN auto recovery* (0 .. 600) sec	2	<input type="text" value="0"/> sec
SyncLoss keepalive timeout (0 .. 10) sec	3	<input type="text" value="3"/> sec
LSP startup timeout (0 .. 3600) sec	4	<input type="text" value="60"/> sec
WAN state	5	UP
Port state	6	UP
SNMP traps	7	<input type="checkbox"/> Enable

*LAN port will recover after synchronization reestablishment, if 0 sec. has been set!

8 Rollback on Execute configuration

- 1) **State** – Indicates current status of Link State Propagation (status mode) and allows disabling or enabling it (modify mode).
- 2) **LAN auto recovery** – Indicates current value of LAN auto recovery (status mode) and allows specifying this value in seconds (modify mode).
- 3) **SyncLoss keepalive timeout** – Indicates current value of SyncLoss keepalive timeout (status mode) and allows specifying this value in seconds (modify mode). If value is 0, LAN port will recover after synchronization reestablishment.
- 4) **LSP startup timeout** – Indicates current value of LSP startup timeout (status mode) and allows specifying this value in seconds (modify mode).
- 5) **WAN state** – Indicates WAN port state.
- 6) **Port state** – Indicates LAN port state.
- 7) **SNMP traps** – Indicate current status of SNMP traps (status mode) and allows disabling or enabling it (modify mode).
- 8) By pressing „Execute configuration” changes made to the corresponding section apply only to the local side Integra-W/Integra-WS. If „Rollback on” is selected, the configuration will be reverted in case erroneous configuration changes are applied.

CLI commands (Chapter 4: COMMAND LINE INTERFACE)

isp [status]	Use to show Link State Propagation status.
isp state {enable disable}	Use to enable/disable Link State Propagation.
isp auto_recovery <seconds>	Use to set LAN auto recovery time in seconds.
isp keepalive <seconds>	Use to set SyncLoss keepalive timeout in seconds.
isp startup <seconds>	Use to set LSP startup timeout in seconds.
isp traps {enable disable}	Use to enable/disable SNMP traps.

Networking → Ethernet → Port status and configuration

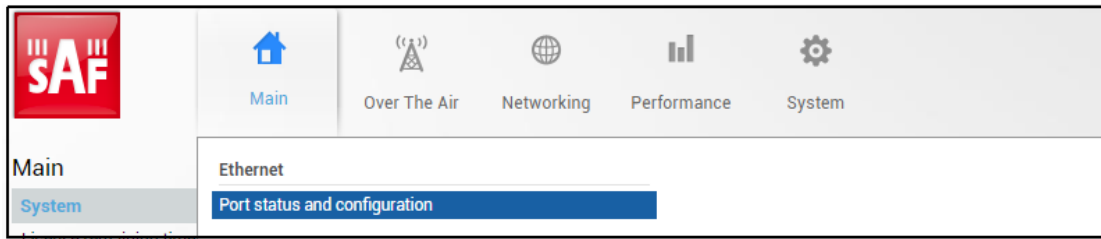

Status mode

Networking / Port status and configuration		
	LAN (SFP) 1	MNG (RJ-45)
State	2 Enabled	Enabled
Link status	3 1000 Mbps	Down
Link speed	4 Auto	Auto
Flow control	5 Disabled	
+ SFP module specification 6		

Press  **MODIFY** button.

Modify mode

Networking / Port status and configuration		
	LAN (SFP) 1	MNG (RJ-45)
State	2 <input checked="" type="checkbox"/> Enable	Enabled
Link status	3 1000 Mbps	Down
Link speed	4 Auto	Auto <input type="text"/>
Flow control	5 <input type="checkbox"/> Enable	
+ SFP module specification 6		
		7 Rollback on <input type="checkbox"/> Execute configuration

- 1) **Port** – Indicates available switch ports. Note that in out-band firmware version (3.xx.x-mux) LAN port configuration (SFP or electrical RJ-45) should be done in the [Networking → Ethernet → Network configuration](#) page.
- 2) **State** – Indicates operation status of each LAN port (status mode); allows enabling/disabling each port (modify mode).
- 3) **Link status** – Indicates whether the link with the appropriate port is established and its link speed.
- 4) **Link speed** – Indicates whether link speed is configured to automatic speed setting or manual (status mode); allows changing link speed to the manual setting (modify mode). Note that it is only possible to change the speed of MNG port (only to 100FDX).

 Only MNG port can be modified to 100FDX. LAN ports support Auto Gigabit (1000FDX) only and cannot be modified.

 Maximum L2 frame size supported for LAN ports is 9600B, for MNG port – 1518B.

- 5) **Flow control** – Indicates whether flow control is enabled or disabled on LAN port (status mode); allows enabling/disabling flow control on LAN port (modify mode). By default, flow control is disabled.
- 6) **SFP module specification** – if SFP module is present, you can expand this section to see information on SFP module used.
- 7) By pressing „Execute configuration” changes made to the corresponding section apply only to the local side Integra-W/Integra-WS. If „Rollback on” is selected, the configuration will be reverted in case erroneous configuration changes are applied.

CLI commands (Chapter 4: COMMAND LINE INTERFACE)

network port show info	Use to show the status of all ports.
network port show config	Use to show the configuration of all ports.
network port set <port> admin-state {enable disable}	Use to enable or disable particular port.
network port set MNG speed {auto 100fdx}	Use to change speed and duplex setting on MNG port. Default value is "auto" (autonegotiation).
network port set LAN flow-control {enable disable}	Use to enable or disable flow control on LAN port.
network port set LAN dpll {async master slave}	Available only in out-band firmware version (3.xx.x-mux). Use to set DPLL operation mode on LAN port.

Performance

Performance → Alarm → Alarm status

The Alarm status page summarizes current alarms by showing date and time the alarm occurred and its name.

Date 1	Time 2	Alarm 3
2015-07-07	13:05:44	State of LAN port [No Link] [0x00000001]

- 1) **Date** – shows date when alarm was initiated.
- 2) **Time** – shows time when alarm was initiated.
- 3) **Alarm** – shows the name of the alarm.

CLI commands (Chapter 4: COMMAND LINE INTERFACE)

log sensor setlist	Use to show alarm status.
---------------------------	---------------------------

Performance → Alarm → Alarm event log

Alarm log shows 20 alarm entries per page and about 5000 alarm entries in total. Full alarm log can be downloaded by pressing on "Alarm event log file". The last page of log entries is shown by default.

Alarm entries are mostly distributed in two groups – "Set" when alarm appears and "Reset" when alarm disappears.

You also have fast access to alarm filtering, where it is possible to choose which alarm groups you are willing to filter out of all log entries.

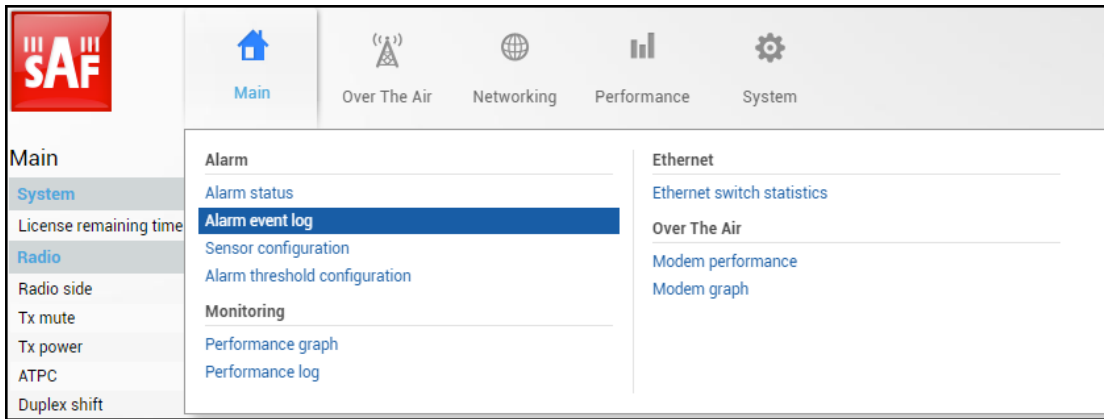

Status mode

Performance / Alarm event log

2 Toggle period selection Load the latest data 3

No.	Date and Time	Source	Status	Event
5046	2015-07-07 13:27:46	radiod[rpc]		Radio Rx frequency set: 17793000 kHz
5047	2015-07-07 13:27:46	Radio	RESET	Rx level [-51 dBm]
5048	2015-07-07 13:27:46	Radio	RESET	Mute status [Mute(Off)] [0x00000000]
5049	2015-07-07 13:27:46	configd[rpc]		Cfg '7820' accepted from 'radio.web.admin'
5050	2015-07-07 13:28:00	configd[rpc]		Cfg without changes from 'config.list'
5051	2015-07-07 13:28:29	rupd[rpc]		Applying configuration for both (#047780A1:0)
5052	2015-07-07 13:28:30	radiod[rpc]		ATPC disabled (#6DAA718F:-3)
5053	2015-07-07 13:28:30	web		admin executed configuration
5054	2015-07-07 13:28:32	Radio	SET	Mute status [Mute(On)] [0x00000001]
5055	2015-07-07 13:28:33	Radio	SET	Rx level [-85 dBm]
5056	2015-07-07 13:28:33	configd[rpc]		Cfg '7821' accepted from 'modem.web.admin'
5057	2015-07-07 13:28:33	radiod[rpc]		Radio power set: 13 dBm
5058	2015-07-07 13:28:33	Modem	SET	Modem synchronization loss [0x00000001]
5059	2015-07-07 13:28:33	Modem	SET	FEC load [100 %]
5060	2015-07-07 13:28:33	Modem	SET	Modem signal quality [0 %]
5061	2015-07-07 13:28:33	radiod[rpc]		Radio Tx frequency set: 19389000 kHz
5062	2015-07-07 13:28:33	radiod[rpc]		Radio Rx frequency set: 17829000 kHz
5063	2015-07-07 13:28:34	Radio	RESET	Rx level [-52 dBm]
5064	2015-07-07 13:28:34	Radio	RESET	Mute status [Mute(Off)] [0x00000000]
5065	2015-07-07 13:28:34	configd[rpc]		Cfg '7822' accepted from 'radio.web.admin'

<< Previous 20 Next 20 >> 5

Select page (1 - 254) Select 6

7 Filter:

[Alarm event log file](#) 8

Press **MODIFY** button.

Modify mode

Performance / Alarm event log

Clear alarm event log 2 Toggle period selection Load the latest data 3

No.	Date and Time	Source	Status	Event
5046	2015-07-07 13:27:46	radiod[rpc]		Radio Rx frequency set: 17793000 kHz
5047	2015-07-07 13:27:46	Radio	RESET	Rx level [-51 dBm]
5048	2015-07-07 13:27:46	Radio	RESET	Mute status [Mute(Off)] [0x00000000]
5049	2015-07-07 13:27:46	configd[rpc]		Cfg '7820' accepted from 'radio.web.admin'
5050	2015-07-07 13:28:00	configd[rpc]		Cfg without changes from 'config.list'
5051	2015-07-07 13:28:29	rupd[rpc]		Applying configuration for both (#047780A1:0)
5052	2015-07-07 13:28:30	radiod[rpc]		ATPC disabled (#6DAA718F:-3)
5053	2015-07-07 13:28:30	web		admin executed configuration
5054	2015-07-07 13:28:32	Radio	SET	Mute status [Mute(On)] [0x00000001]
5055	2015-07-07 13:28:33	Radio	SET	Rx level [-85 dBm]
5056	2015-07-07 13:28:33	configd[rpc]		Cfg '7821' accepted from 'modem.web.admin'
5057	2015-07-07 13:28:33	radiod[rpc]		Radio power set: 13 dBm
5058	2015-07-07 13:28:33	Modem	SET	Modem synchronization loss [0x00000001]
5059	2015-07-07 13:28:33	Modem	SET	FEC load [100 %]
5060	2015-07-07 13:28:33	Modem	SET	Modem signal quality [0 %]
5061	2015-07-07 13:28:33	radiod[rpc]		Radio Tx frequency set: 19389000 kHz
5062	2015-07-07 13:28:33	radiod[rpc]		Radio Rx frequency set: 17829000 kHz
5063	2015-07-07 13:28:34	Radio	RESET	Rx level [-52 dBm]
5064	2015-07-07 13:28:34	Radio	RESET	Mute status [Mute(Off)] [0x00000000]
5065	2015-07-07 13:28:34	configd[rpc]		Cfg '7822' accepted from 'radio.web.admin'

<< Previous 20 Next 20 >> 5

Select page (1 - 254) 254 Select 6

7 Filter: No filter

Alarm event log file 8

- 1) **Clear alarm log** – deletes all alarm log entries.
- 2) **Toggle period selection** – opens/closes period selection controls:

Toggle period selection Load the latest data

From date (yyyy-mm-dd) Time (hh:mm)

Till date (yyyy-mm-dd) Time (hh:mm)

Set period

- 3) **Load the latest data** – refreshes alarm log and shows last 20 log entries.
- 4) List of alarm log entries – entry number, date and time, source node, status and event name. Clicking on “Cfg # accepted from <>” will redirect to Configuration file page and highlight changes made.
- 5) Navigation controls. “<<” navigates to start of alarm log, while “>>” – to the end; “Previous 20” navigates to previous alarm log page showing 20 previous alarm log entries, while “Next 20” – to next alarm log page showing 20 next alarm log entries (if available).
- 6) Shows the number of the currently viewed alarm log page. You can enter the specific page number to navigate to the required page.
- 7) **Filter** – press to filter alarms from certain source node (e.g., Radio);
- 8) **Alarm event log file** – press the link to download full alarm log text file.

CLI commands (Chapter 4: COMMAND LINE INTERFACE)

log event show last <#_of_entries>	Use to show a certain number of last alarm log entries.
log event show time <starttime> [<endtime>]	Use to show entries from a certain time point. Following formats are supported: YYYY-MM-DD/hh:mm:ss; MM-DD/hh:mm:ss; MM-DD/hh:mm; hh:mm:ss; hh:mm
log event show sensor <sensor> [last <#_of_entries >] [time <starttime> [<endtime>]]	Use to show entries for a specific sensor. Regarding subcommands “last” and “time” refer to command above.

log event show module {alarm_only iman modem ns psu radio system} [last <#_of_entries>] [time <starttime> <endtime>]	Use to show entries for a specific module. Regarding subcommands "last" and "time" refer to commands above.
log event clear	Use to clear alarm log.
log event configure {enable disable}	Use to enable/disable grouped repetitive alarm-event log entries.
log event configure dump <1...60>	Use to configure duration in minutes during which filter is monitoring repetitions.
log event configure pattern <1...10>	Use to configure a number of log entry repetitions to be monitored.
log event configure sn_hide_sev <0...7>	Use to set alarm severity levels (up to and including) to be excluded from logging; the levels are: 0 – emergency, 1 – alert, 3 – error, 4 – warning, 5 – notice, 6 – info, 7 – debug; the default value is "4".
log event configure status	Use to display the current configuration of grouped repetitive alarm-event log entries (filter).

Performance → Alarm → Sensor configuration

The following section allows configuring behavior of available sensor parameters.

 After the firmware upgrade, it is required to reset sensor configuration to default using "Set all to default" button and reconfigure sensors as required.

 It is not recommended to add "License remaining time" sensor parameter to performance log ("perf") data destination.

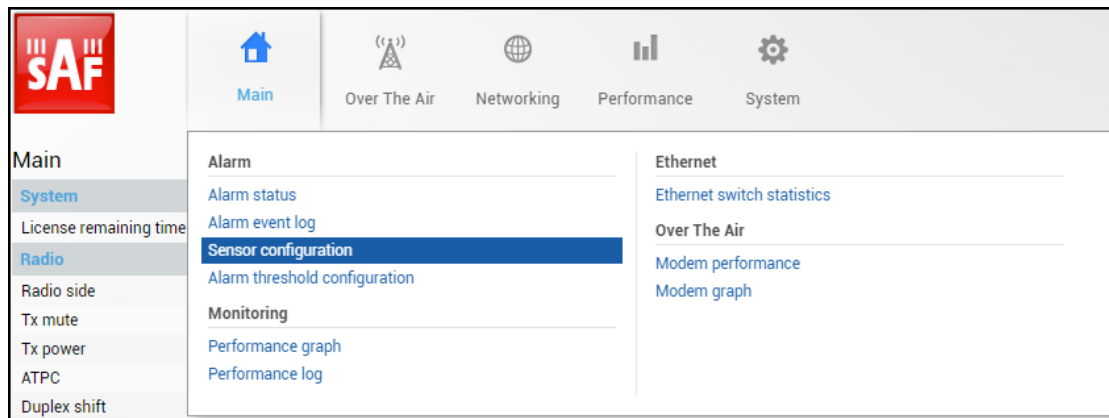

Status mode

Performance / Sensor configuration

1	Group description (name)	State	Data destination			
			Alarm log	PM log	SNMP	Syslog
+ Alarm log only (alarm_only)	Enabled	✓	✗	✗	✓	
+ PM log only (log_only)	Enabled	✗	✓	✗	✗	
+ Full monitoring (default_all)	Enabled	✓	✓	✓	✓	
+ Alarm log and... (alarm_snmp)	Enabled	✓	✗	✓	✓	
+ PM log and SNMP (pm_snmp)	Enabled	✗	✓	✓	✗	

Ungrouped sensor list (5) **2**

Admin state of LAN port	✓
Modem ACM Rx	✓
Modem MSE	✗
Rx Capacity	✗
Tx Capacity	✗

Press MODIFY button.

Modify mode

Performance / Sensor configuration

1	Group description (name)	State	Data destination			
			Alarm log	PM log	SNMP	Syslog
+ Alarm log only (alarm_only)	<input checked="" type="checkbox"/>	<input checked="" type="checkbox"/>	<input type="checkbox"/>	<input type="checkbox"/>	<input checked="" type="checkbox"/>	
+ PM log only (log_only)	<input checked="" type="checkbox"/>	<input type="checkbox"/>	<input checked="" type="checkbox"/>	<input type="checkbox"/>	<input type="checkbox"/>	
+ Full monitoring (default_all)	<input checked="" type="checkbox"/>	<input checked="" type="checkbox"/>	<input checked="" type="checkbox"/>	<input checked="" type="checkbox"/>	<input checked="" type="checkbox"/>	
+ Alarm log and... (alarm_snmp)	<input checked="" type="checkbox"/>	<input checked="" type="checkbox"/>	<input type="checkbox"/>	<input checked="" type="checkbox"/>	<input checked="" type="checkbox"/>	
+ PM log and SNMP (pm_snmp)	<input checked="" type="checkbox"/>	<input type="checkbox"/>	<input checked="" type="checkbox"/>	<input checked="" type="checkbox"/>	<input type="checkbox"/>	

Ungrouped sensor list (5) **2**

Admin state of LAN port	<input checked="" type="checkbox"/>
Modem ACM Rx	<input checked="" type="checkbox"/>
Modem MSE	<input type="checkbox"/>
Rx Capacity	<input type="checkbox"/>
Tx Capacity	<input type="checkbox"/>

3
 4
 5
 6

- 1) **Group description (name)** – Shows 5 groups of sensors divided by different group data destinations (event; perf; snmp), as well as indicates whether group is enabled (state);
- 2) **Ungrouped sensor list** – Shows list of sensors not added to any of existing groups (status mode); allows dragging to any of existing groups, thus specifying how the sensor will be treated. Unchecking the checkbox next to the sensor disables the sensor (modify mode).
- 3) **Add group** – Allows creating a new group with custom name and description.

✕

Group name (<13 characters):

Allowed: A-Z;a-z;0-9;-;_

Group description (<41 characters):

Afterwards, sensors from ungrouped sensor list or other groups can be added to the group by dragging in.

- 4) **Remove group** – Allows deleting existing groups via a dialog window.

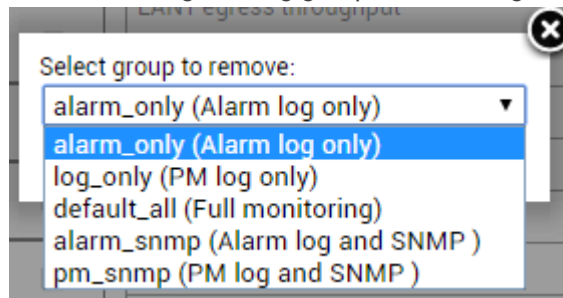

- 5) **Set all to default** – Restores default settings for all groups and sensors.
 6) By pressing „Execute configuration“, changes made to the corresponding section apply only to the local side Integra-W/Integra-WS.

CLI commands (Chapter 4: COMMAND LINE INTERFACE)

log group info	Use to show sensor group configuration.
log group create <name> <description>	Use to create a new group.
log group mgmt <name> add destination {event perf snmp syslog}	Use to add a destination for a group.
log group mgmt <name> add sensor <sensor>	Use to add a sensor to a group.
log group mgmt <name> config {enable disable}	Use to enable or disable a group.
log group mgmt <name> delete	Use to delete a group.
log group mgmt <name> remove destination {event perf snmp syslog}	Use to remove a destination from a group.
log group mgmt <name> remove sensor <sensor>	Use to remove a sensor from a group.
log sensor list	Use to list all available sensors.

Performance → Alarm → Alarm threshold configuration

The page provides a summary of parameters' alarm thresholds. All thresholds are predefined and some change dynamically according to system configuration. Thresholds can be modified if required.

Alarm activates when current value exceeds (low-delta) or (high+delta) values. Alarm deactivates when current value exceeds (low+delta) or (high-delta) values.

The screenshot shows the SAF web GUI interface. At the top, there is a navigation bar with icons for Main, Over The Air, Networking, Performance, and System. The 'Performance' icon is active. Below the navigation bar, there is a sidebar menu on the left with categories: Main, System, License remaining time, Radio, Radio side, Tx mute, Tx power, ATPC, and Duplex shift. The 'Main' category is expanded, showing sub-items: Alarm, Monitoring, Ethernet, and Over The Air. The 'Alarm' sub-item is further expanded, showing: Alarm status, Alarm event log, Sensor configuration, Alarm threshold configuration (highlighted in blue), Performance graph, and Performance log.

Status mode

Performance / Alarm threshold configuration				
Alarm name	Low value	High value	Delta value	Current value
PSU current	0.350 A	1.100 A	0.050 A	0.704 A
PSU voltage	36.00 V	58.00 V	2.00 V	44.60 V
PSU power	18.00 W	40.00 W	2.00 W	31.40 W
Modem signal quality	62 %		0 %	100 %
FEC load		90 %		0 %
Rx Modulation				32 points
Tx Modulation				32 points
Radio temperature	-40.0 C	80.0 C	2.0 C	59.0 C
Rx level	-77 dBm	-30 dBm	2 dB	-38 dBm
ATPC Tx power correction				N/A
Tx power				2 dBm
6.5 V	5.90 V	7.10 V	0.02 V	6.54 V
5.0 V	4.50 V	5.50 V	0.02 V	5.01 V
3.3 V	3.00 V	3.60 V	0.02 V	3.28 V
2.5 V	2.30 V	2.70 V	0.02 V	2.49 V
1.8 V	1.71 V	1.89 V	0.02 V	1.82 V
1.5 V	1.14 V	1.89 V	0.02 V	1.55 V
1.0 V	0.97 V	1.04 V	0.02 V	0.99 V
System free physical memory				92.1 %
System CPU idle				91.3 %
System temperature	-40.0 C	100.0 C	2.0 C	61.0 C
System CPU temperature	-40.0 C	100.0 C	2.0 C	71.4 C
License remaining time	15d 00:00:00			N/A
System uptime				0d 18:40:26

Press  MODIFY button.

Modify mode

Performance / Alarm threshold configuration						
Alarm name	Low value	High value	Delta value	Current value	Default value	
PSU current	<input type="text" value="0.350"/> A	<input type="text" value="1.100"/> A	<input type="text" value="0.050"/> A	0.704 A	<input checked="" type="checkbox"/>	3
PSU voltage	<input type="text" value="36.00"/> V	<input type="text" value="58.00"/> V	<input type="text" value="2.00"/> V	44.60 V	<input checked="" type="checkbox"/>	
PSU power	<input type="text" value="18.00"/> W	<input type="text" value="40.00"/> W	<input type="text" value="2.00"/> W	31.40 W	<input checked="" type="checkbox"/>	
Modem signal quality	<input type="text" value="62"/> %		<input type="text" value="0"/> %	100 %	<input checked="" type="checkbox"/>	
FEC load		<input type="text" value="90"/> %		0 %	<input checked="" type="checkbox"/>	
Rx Modulation				32 points		
Tx Modulation				32 points		
Radio temperature	<input type="text" value="-40.0"/> C	<input type="text" value="80.0"/> C	<input type="text" value="2.0"/> C	59.0 C	<input checked="" type="checkbox"/>	
Rx level	<input type="text" value="-77"/> dBm	<input type="text" value="-30"/> dBm	<input type="text" value="2"/> dB	-38 dBm	<input type="checkbox"/>	
ATPC Tx power correction				N/A		
Tx power				2 dBm		
6.5 V	<input type="text" value="5.90"/> V	<input type="text" value="7.10"/> V	<input type="text" value="0.02"/> V	6.54 V	<input checked="" type="checkbox"/>	
5.0 V	<input type="text" value="4.50"/> V	<input type="text" value="5.50"/> V	<input type="text" value="0.02"/> V	5.01 V	<input checked="" type="checkbox"/>	
3.3 V	<input type="text" value="3.00"/> V	<input type="text" value="3.60"/> V	<input type="text" value="0.02"/> V	3.28 V	<input checked="" type="checkbox"/>	
2.5 V	<input type="text" value="2.30"/> V	<input type="text" value="2.70"/> V	<input type="text" value="0.02"/> V	2.49 V	<input checked="" type="checkbox"/>	
1.8 V	<input type="text" value="1.71"/> V	<input type="text" value="1.89"/> V	<input type="text" value="0.02"/> V	1.82 V	<input checked="" type="checkbox"/>	
1.5 V	<input type="text" value="1.14"/> V	<input type="text" value="1.89"/> V	<input type="text" value="0.02"/> V	1.56 V	<input checked="" type="checkbox"/>	
1.0 V	<input type="text" value="0.97"/> V	<input type="text" value="1.04"/> V	<input type="text" value="0.02"/> V	0.99 V	<input checked="" type="checkbox"/>	
System free physical memory				92.1 %		
System CPU idle				79.1 %		
System temperature	<input type="text" value="-40.0"/> C	<input type="text" value="100.0"/> C	<input type="text" value="2.0"/> C	60.5 C	<input checked="" type="checkbox"/>	
System CPU temperature	<input type="text" value="-40.0"/> C	<input type="text" value="100.0"/> C	<input type="text" value="2.0"/> C	71.6 C	<input checked="" type="checkbox"/>	
License remaining time	<input type="text" value="15d 00:00:00"/>			N/A	<input checked="" type="checkbox"/>	
System uptime				0d 18:44:27		
Set all to default 2				Execute configuration 4		

- 1) Indicates low, high and delta values of the parameters (status mode); “Low value”, “High value” and “Delta value” fields for all parameters become editable when “Default value” is deselected (modify mode).
- 2) **Set all to default** – resets “Low value”, “High value” and “Delta value” for all parameters to factory defaults.
- 3) **Default value** – deselect to activate manual threshold modification.
- 4) By pressing „Execute configuration” changes made to the corresponding section apply only to the local side Integra-W/Integra-WS.

CLI commands (Chapter 4: COMMAND LINE INTERFACE)

log sensor info	Use to show the configuration of sensor thresholds.
log sensor mgmt <sensor> control {enable disable}	Use to enable or disable a sensor.
log sensor mgmt <sensor> thold <min> <max> <delta>	Use to set sensor’s min, max thresholds and delta value manually.
log sensor mgmt <sensor> time <0...30>	Use to set sensor hysteresis time in seconds. Will be used to show value in orange color indicating that sensor value recently exceeded its thresholds.
log default {all group sensors [sensor]}	Use to set group, individual sensor or all sensor configuration to default.

log sensor list	Use to list all available sensors.
------------------------	------------------------------------

Performance → Monitoring → Performance graph

Performance graph allows visualizing various parameters over a chosen time period as curves. Available parameters will depend on the [Performance → Alarm → Sensor configuration](#). Any two parameters can be shown at a time. By default, Rx level (dBm) and FEC load (%) are selected.

 Not all sensors available in [Performance → Alarm → Sensor configuration](#) can be displayed in the Performance graph.

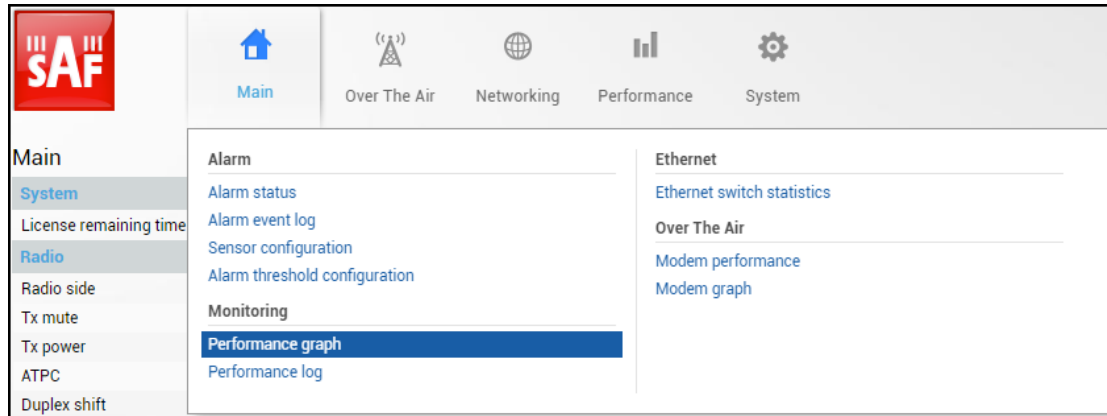

MODIFY button is deactivated in Performance graph page.

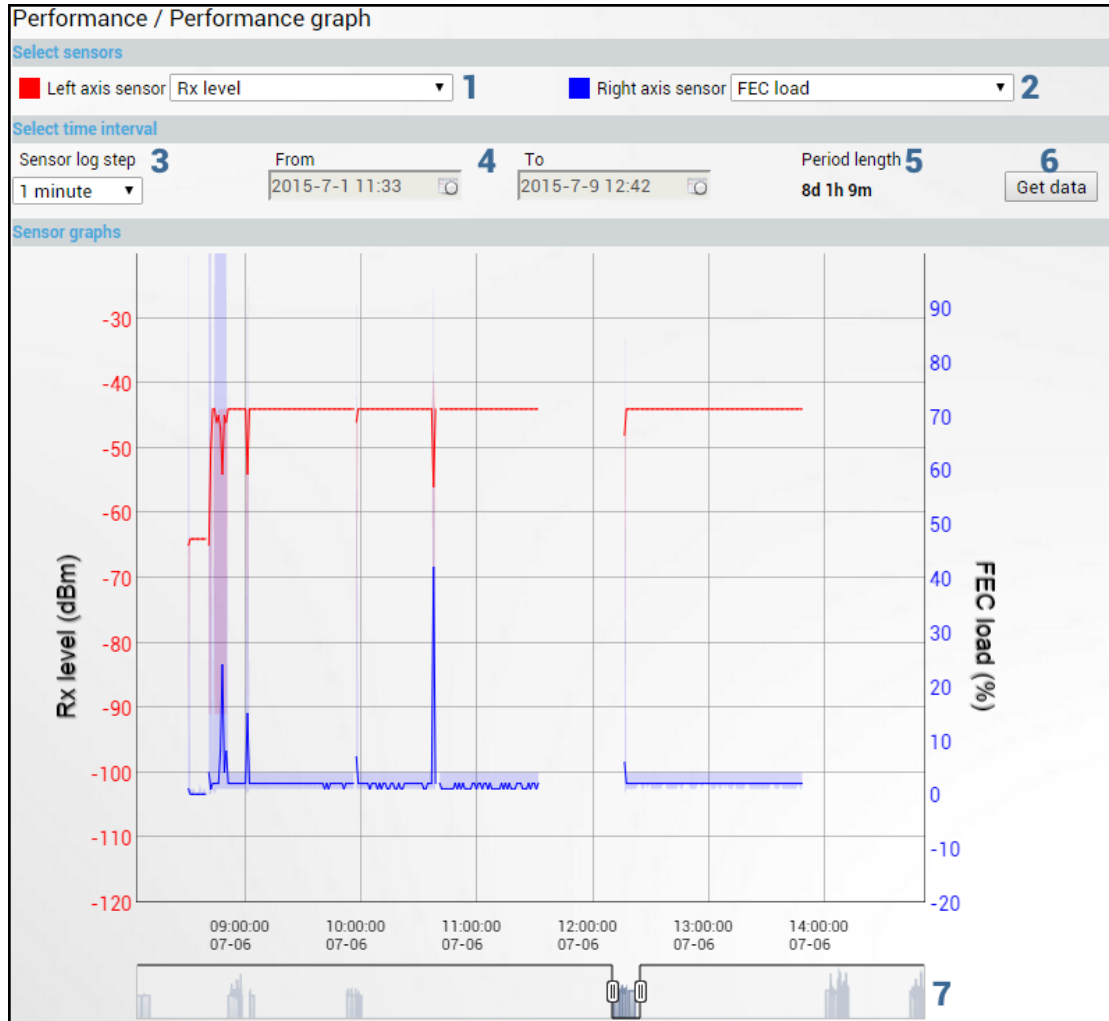

- 1) **Left axis sensor** – Allows choosing sensor parameter colored in red and displayed on the left axis.
- 2) **Right axis sensor** – Allows choosing sensor parameter colored in blue and displayed on the right axis.
- 3) **Sensor log step** – Allows choosing graph granularity – 1, 15 or 60 minutes.
- 4) Indicates start and end date/time of period displayed and allows selecting specific period to show.
- 5) **Period length** – Indicates length of the currently displayed period.
- 6) **Get data** – Press to apply selected time interval changes.
- 7) Left and right sliders allow to “zoom” currently selected time period.

Performance → Monitoring → Performance log

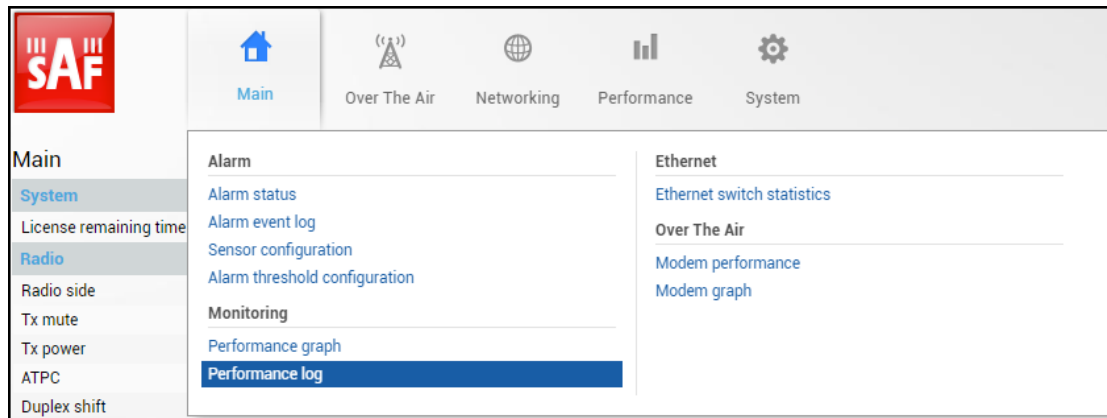

MODIFY button is deactivated in Performance log page.

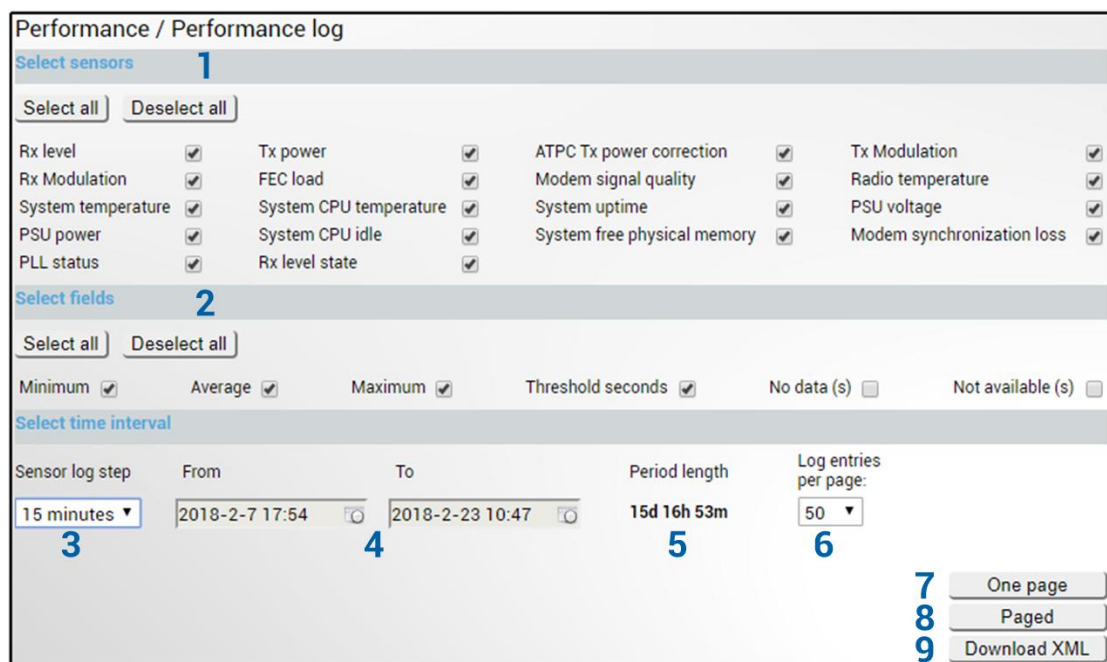

- 1) **Select sensors** – Allows choosing sensor parameters to be displayed in performance log.
- 2) **Select fields** – Allows choosing parameter fields to be displayed in performance log. “Minimum” and “Maximum” represent minimum and maximum values in specified sensor log step, while “Average” displays average value; “Threshold seconds” will show number of seconds in chosen time interval when parameter exceeded minimum or maximum alarm thresholds; “No data (s)” and “Not available (s)” show respectively time when there was no data of according parameter and it was not available.
- 3) **Sensor log step** – Allows choosing log step – 1, 15 or 60 minutes.
- 4) Indicates start and end date/time of period displayed and allows selecting specific period to show.
- 5) **Period length** – Indicates length of the currently displayed period.
- 6) **Log entries per page** – Allows choosing 20, 50 or 100 entries per page for Paged representation.
- 7) **One page** – Will display performance log on a single page in a separate tab.
- 8) **Paged** – Will display performance log divided into pages in a separate tab.

- 9) **Download XML** – Press to download performance log in an extensible markup language (.xml) file.

CLI commands (Chapter 4: COMMAND LINE INTERFACE)

log {1M 15M 60M} <1...1440> <sensor>	perf	show last	Use to show a specified number of last performance log entries with specified sensor log step.
log {1M 15M 60M} <starttime> <sensor>	perf	show time <endtime>	Use to show entries for a certain time frame. Following formats are supported: YYYY-MM-DD/hh:mm:ss; MM-DD/hh:mm:ss; MM-DD/hh:mm; hh:mm:ss; hh:mm
log perf clear			Use to clear performance log.

Performance → Ethernet → Ethernet switch statistics

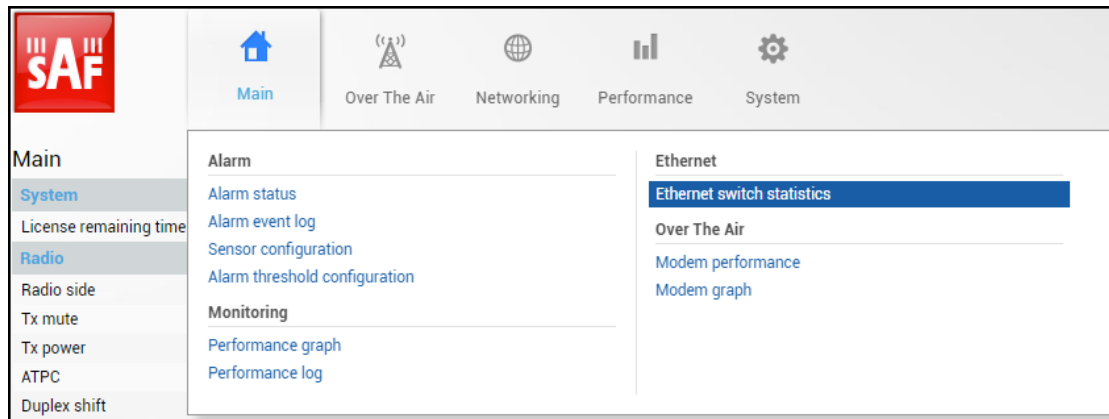

Status mode (out-band management FW version – 3.xx.x-mux)

Performance / Ethernet switch statistics			
		LAN	MNG
Statistics for	1	0d 00:05:41	0d 00:05:41
Rx Detected	2	31485464	0
Rx Dropped	3	0	0
Tx Detected	4	31485460	0
Tx Dropped	5	0	0
Rx Bytes	6	22573692664	0
Tx Bytes	7	22573688993	0
Rx 64 byte frames	8	54260	N/A
Rx 65 - 127 byte frames	9	3418064	N/A
Rx 128 - 255 byte frames	10	9743895	N/A
Rx 256 - 511 byte frames	11	2558228	N/A
Rx 512 - 1023 byte frames	12	5489062	N/A
Rx 1024 - Max byte frames	13	5489041	N/A
Rx Undersize frames	14	0	N/A
Rx Oversize frames	15	4732914	N/A
Tx 64 byte frames	16	54256	N/A
Tx 65 - 127 byte frames	17	3418054	N/A
Tx 128 - 255 byte frames	18	9743928	N/A
Tx 256 - 511 byte frames	19	2558216	N/A
Tx 512 - 1023 byte frames	20	5489088	N/A
Tx 1024 - Max byte frames	21	5488979	N/A
Tx Undersize frames	22	0	N/A
Tx Oversize frames	23	4732939	N/A
Rx Good frames	24	31485466	N/A
Rx Errors	25	N/A	0
Rx FIFO errors	26	N/A	0
Rx CRC errors	27	0	N/A
Rx Broadcast frames	28	0	N/A
Rx Multicast frames	29	0	0
Rx Control frames	30	0	N/A
Rx Length errors	31	0	N/A
Rx VLAN frames	32	0	N/A
Rx Pause frames	33	0	N/A
Rx Op errors	34	0	N/A
Rx Frame errors	35	N/A	0
Tx Good frames	36	35408758	N/A
Tx Errors	37	N/A	0
Tx FIFO err	38	N/A	0
Tx Broadcast frames	39	0	N/A
Tx Multicast frames	40	0	N/A
Tx Underrun errors	41	0	N/A
Tx Control frames	42	0	N/A
Tx VLAN frames	43	0	N/A
Tx Pause frames	44	0	N/A
Tx Single collisions	45	0	N/A
Tx Multi collisions	46	0	N/A
Tx Deferred	47	0	N/A
Tx Late collisions	48	0	N/A
Tx Excess collisions	49	0	N/A
Tx Excess deferral	50	0	N/A
Tx Alignment errors	51	0	N/A
Tx Carrier errors	52	N/A	0
Tx Collisions	53	N/A	0

Press  **MODIFY** button.

Modify mode (buttons appear at the bottom of the page)

<input type="button" value="Clear all data"/>	<input type="button" value="Clear"/>	<input type="button" value="Clear"/>
-----------------------------------------------	--------------------------------------	--------------------------------------

- 1) **Statistics for** – time during which statistics have been gathered.
- 2) **Rx detected** – The total number of packets detected on port's ingress.
- 3) **Rx dropped** – The total number of packets dropped on port's ingress.
- 4) **Tx detected** – The total number of packets detected on port's egress.
- 5) **Tx dropped** – The total number of packets dropped on port's egress.
- 6) **Rx Bytes** – Bytes on port's ingress.
- 7) **Tx Bytes** – Bytes on port's egress.
- 8) **Rx 64 byte frames** – The total number of 64-byte frames on port's ingress.
- 9) **Rx 65 - 127 byte frames** – The total number of 65...127-byte frames on port's ingress.
- 10) **Rx 128 - 255 byte frames** – The total number of 128...255-byte frames on port's ingress.
- 11) **Rx 256 - 511 byte frames** – The total number of 256...511-byte frames on port's ingress.
- 12) **Rx 512 - 1023 byte frames** – The total number of 512...1023-byte frames on port's ingress.
- 13) **Rx 1024 - Max byte frames** – The total number of 1024...1522-byte frames on port's ingress.
- 14) **Rx Undersize frames** – The total number of packets received that were less than 64 octets long (excluding framing bits but including FCS octets) and were otherwise well formed.
- 15) **Rx Oversize frames** – The total number of packets received that were longer than 1522 octets (excluding framing bits but including FCS octets) and were otherwise well formed.
- 16) **Tx 64 byte frames** – The total number of 64-byte frames on port's egress.
- 17) **Tx 65 - 127 byte frames** – The total number of 65...127-byte frames on port's egress.
- 18) **Tx 128 - 255 byte frames** – The total number of 128...255-byte frames on port's egress.
- 19) **Tx 256 - 511 byte frames** – The total number of 256...511-byte frames on port's egress.
- 20) **Tx 512 - 1023 byte frames** – The total number of 512...1023-byte frames on port's egress.
- 21) **Tx 1024 - Max byte frames** – The total number of 1024...1522-byte frames on port's egress.
- 22) **Tx Undersize frames** – The total number of packets sent that were less than 64 octets long (excluding framing bits but including FCS octets) and were otherwise well formed.
- 23) **Tx Oversize frames** – The total number of packets transmitted that were longer than 1522 octets (excluding framing bits but including FCS octets) and were otherwise well formed.
- 24) **Rx Good frames** – The number of frames that have been received by this port from its segment excluding fragmented and FCS error frames.
- 25) **Rx Errors** – The number of fragmented and FCS error frames.
- 26) **Rx FIFO errors** – The number of frames out of the sequence received by this port.
- 27) **Rx CRC errors** – The number of frames with the wrong CRC received by this port.
- 28) **Rx Broadcast frames** – The total number of good packets received that were directed to the broadcast address. Note that this does not include multicast packets.

- 29) **Rx Multicast frames** – The total number of good packets received that were directed to a multicast address. Note that this number does not include packets directed to the broadcast address.
- 30) **Rx Control frames** – The total number of frames received as control frames.
- 31) **Rx Length errors** – The total number of frames received with incorrect length field.
- 32) **Rx VLAN frames** – The total number of frames received containing at least one VLAN tag.
- 33) **Rx Pause frames** – The total number of frames received as control frames with valid PAUSE opcodes.
- 34) **Rx Op errors** – The total number of frames recognized as control frames but contained an Unknown Opcode.
- 35) **Rx Frame errors** – The total number of frames received with errors.
- 36) **Tx Good frames** – The number of frames that have been transmitted by this port from its segment excluding fragmented and FCS error frames.
- 37) **Tx Errors** – The number of fragmented and FCS error frames.
- 38) **Tx FIFO err** – The number of frames out of the sequence transmitted by this port.
- 39) **Tx Broadcast frames** – The total number of good packets transmitted that were directed to the broadcast address. Note that this does not include multicast packets.
- 40) **Tx Multicast frames** – The total number of good packets transmitted that were directed to a multicast address. Note that this number does not include packets directed to the broadcast address.
- 41) **Tx Underrun errors** – The number of packets transmitted that are less than the allowed 64 octets minimum length. Underrun packets occur due to jam signals generated by collisions, backpressure etc.
- 42) **Tx Control frames** – The total number of frames transmitted as control frames.
- 43) **Tx VLAN frames** – The total number of frames transmitted containing at least one VLAN tag.
- 44) **Tx Pause frames** – The total number of frames transmitted as control frames with valid PAUSE opcodes.
- 45) **Tx Single collisions** – The total number of packets successfully transmitted by this port that experienced exactly one collision.
- 46) **Tx Multi collisions** – The total number of frames successfully transmitted by this port that experienced more than one collision.
- 47) **Tx Deferred** – The total number of frames transmitted by this port for which the first transmission attempt was delayed because the medium was busy.
- 48) **Tx Late collisions** – The total number of times that a collision was detected later than 512 bit-times into the transmission of a frame.
- 49) **Tx Excess collisions** – The total number of frames that were not transmitted from this port because 16 unsuccessful attempts were made to transmit the frame.
- 50) **Tx Excess deferral** – The total number of frames that deferred transmission for an excessive period of time.
- 51) **Tx Alignment errors** – Asserted for received frames of size 64-bytes and greater which contained an odd number of received nibbles and which also contained an invalid FCS field.
- 52) **Tx Carrier errors** – A Number of frames transmitted in which the carrier signal was lost or in which the carrier signal was not present.
- 53) **Tx Collisions** – The total number of collisions experienced by this port during packet transmissions.

Status mode (in-band management FW version – 3.xx.x-esw)

Performance / Ethernet switch statistics							
		LAN	WAN	GFP	MNGINT	MNGCPU	MNGLAN
Statistics for	1	0d 00:18:54	0d 00:18:54	0d 00:18:54	0d 00:18:54	0d 00:18:54	0d 00:18:54
Tx Detected	2	N/D	10265	N/D	8775	10265	10190
Rx Detected	3	0	8775	N/D	10265	8773	8618
Rx CRC errors	4	0	0	0	0	N/D	N/D
Rx Length errors	5	0	0	N/D	0	N/D	N/D
Rx Bytes	6	N/D	N/D	9727554	N/D	9460246	1416304
Tx Bytes	7	N/D	N/D	9495466	N/D	9685216	7540856
Rx Good frames	8	N/D	N/D	10265	N/D	N/D	N/D
Rx Frame errors	9	N/D	N/D	0	N/D	0	0
Rx Broadcast frames	10	N/D	N/D	277	N/D	N/D	N/D
Rx Multicast frames	11	N/D	N/D	1324	N/D	0	0
Rx Control frames	12	N/D	N/D	0	N/D	N/D	N/D
Rx VLAN frames	13	N/D	N/D	0	N/D	N/D	N/D
Rx Pause frames	14	N/D	N/D	0	N/D	N/D	N/D
Tx Good frames	15	N/D	N/D	8775	N/D	N/D	N/D
Tx Broadcast frames	16	N/D	N/D	3	N/D	N/D	N/D
Tx Multicast frames	17	N/D	N/D	2	N/D	N/D	N/D
Tx Underrun errors	18	N/D	N/D	0	N/D	N/D	N/D
Tx VLAN frames	19	N/D	N/D	0	N/D	N/D	N/D
Tx Pause frames	20	N/D	N/D	2	N/D	N/D	N/D
Rx Dropped	21	N/D	N/D	N/D	N/D	0	0
Tx Dropped	22	N/D	N/D	N/D	N/D	0	0
Rx Errors	23	N/D	N/D	N/D	N/D	0	0
Rx FIFO errors	24	N/D	N/D	N/D	N/D	0	0
Tx Errors	25	N/D	N/D	N/D	N/D	0	0
Tx FIFO err	26	N/D	N/D	N/D	N/D	0	0
Tx Carrier errors	27	N/D	N/D	N/D	N/D	0	0
Tx Collisions	28	N/D	N/D	N/D	N/D	0	0

Press  **MODIFY** button.

Modify mode (buttons appear at the bottom of the page)

<input type="button" value="Clear all data"/>	<input type="button" value="Clear"/>	<input type="button" value="Clear"/>	<input type="button" value="Clear"/>	<input type="button" value="Clear"/>	<input type="button" value="Clear"/>	<input type="button" value="Clear"/>
-----------------------------------------------	--------------------------------------	--------------------------------------	--------------------------------------	--------------------------------------	--------------------------------------	--------------------------------------

- 1) **Statistics for** – time during which statistics have been gathered.
- 2) **Tx detected** – The total number of packets detected on port's egress.
- 3) **Rx detected** – The total number of packets detected on port's ingress.
- 4) **Rx CRC errors** – The number of frames with the wrong CRC received by this port.
- 5) **Rx Length errors** – The total number of frames received with incorrect length field.
- 6) **Rx Bytes** – Bytes on port's ingress.
- 7) **Tx Bytes** – Bytes on port's egress.
- 8) **Rx Good frames** – The number of frames that have been received by this port from its segment excluding fragmented and FCS error frames.
- 9) **Rx Frame errors** – The total number of frames received with errors.
- 10) **Rx Broadcast frames** – The total number of good packets received that were directed to the broadcast address. Note that this does not include multicast packets.
- 11) **Rx Multicast frames** – The total number of good packets received that were directed to a multicast address. Note that this number does not include packets directed to the broadcast address.
- 12) **Rx Control frames** – The total number of frames received as control frames.
- 13) **Rx VLAN frames** – The total number of frames received containing at least one VLAN tag.

- 14) **Rx Pause frames** – The total number of frames received as control frames with valid PAUSE opcodes.
- 15) **Tx Good frames** – The number of frames that have been transmitted by this port from its segment excluding fragmented and FCS error frames.
- 16) **Tx Broadcast frames** – The total number of good packets transmitted that were directed to the broadcast address. Note that this does not include multicast packets.
- 17) **Tx Multicast frames** – The total number of good packets transmitted that were directed to a multicast address. Note that this number does not include packets directed to the broadcast address.
- 18) **Tx Underrun errors** – The number of packets transmitted that are less than the allowed 64 octets minimum length. Underrun packets occur due to jam signals generated by collisions, backpressure etc.
- 19) **Tx VLAN frames** – The total number of frames transmitted containing at least one VLAN tag.
- 20) **Tx Pause frames** – The total number of frames transmitted as control frames with valid PAUSE opcodes.
- 21) **Rx dropped** – The total number of packets dropped on port’s ingress.
- 22) **Tx dropped** – The total number of packets dropped on port’s egress.
- 23) **Rx Errors** – The number of fragmented and FCS error frames.
- 24) **Rx FIFO errors** – The number of frames out of the sequence received by this port.
- 25) **Tx Errors** – The number of fragmented and FCS error frames.
- 26) **Tx FIFO err** – The number of frames out of the sequence transmitted by this port.
- 27) **Tx Carrier errors** – A number of frames transmitted in which the carrier signal was lost or in which the carrier signal was not present.
- 28) **Tx Collisions** – The total number of collisions experienced by this port during packet transmissions.

CLI commands (Chapter 4: COMMAND LINE INTERFACE)

network port show statistics	Use to show Ethernet statistics on all ports.
network port reset statistics {LAN MNG all}	Use to reset Ethernet statistics for a particular port or all ports in out-band management FW version.
network port reset statistics {GFP LAN MNGCPU MNGINT MNGLAN WAN all}	Use to reset Ethernet statistics for a particular port or all ports in in-band management FW version.

Performance → Over The Air → Modem performance

The Modem performance section shows modem statistics according to ITU-T G.826.

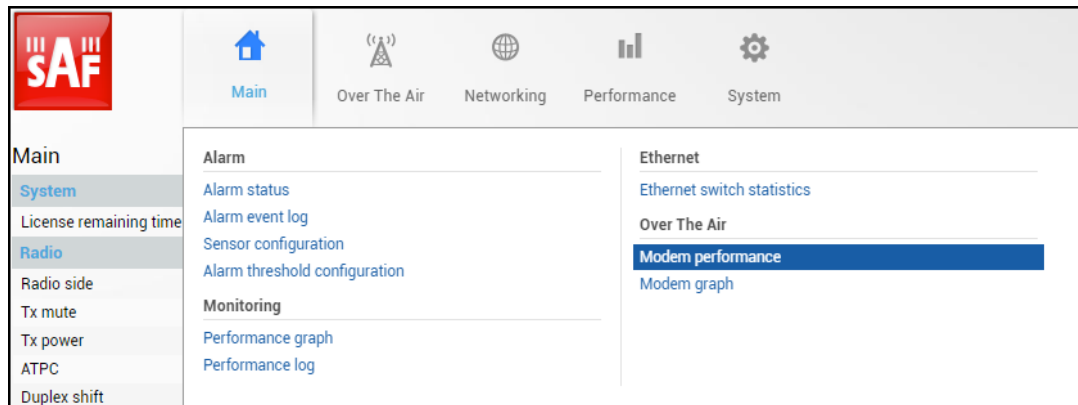

Status mode

Performance / Modem performance		
Count Time	1	21:22:24
Errored Block	2	0
Errored Second	3	0
Severely Errored Second	4	0
Background Block Error	5	0
Total Block Number	6	2104787618
Errored Second Ratio	7	0.0e+00
Severely Errored Second Ratio	8	0.0e+00
Background Block Error Ratio	9	0.0e+00
Uptime	10	21:22:24
Unavailtime	11	00:00:00

Press MODIFY button.

Modify mode (buttons appear at the bottom of the page)



- 1) **Count time** – the time during which statistics are gathered.
- 2) **Errored Block (EB)** – Number of blocks having at least one-bit error.
- 3) **Errored Second (ES)** – Number of seconds during which errored blocks were registered.
- 4) **Severely Errored Seconds (SES)** – Number of seconds that contain 30% errored blocks or one or more defects.
- 5) **Background Block Error (BBE)** – Number of errored blocks that are not part of SES.
- 6) **Total Block number**- Number of blocks received which are not part of SES.
- 7) **Errored Second Ratio (ESR)** – The ratio of ES to total seconds.
- 8) **Severely Errored Second Ratio (SESER)** – The ratio of SES to total seconds.
- 9) **Background Block Error Ratio (BBER)** – The ratio of BBE to total seconds.
- 10) **Uptime** – time in seconds during which the link was synchronized.
- 11) **Unavailtime** – time in seconds during which the link was not synchronized.
- 12) **Clear** – Clears all counters.

CLI commands (Chapter 4: COMMAND LINE INTERFACE)

modem performance	Use to check modem statistics according to ITU-T G.826. See the detailed description above.
modem performance clear	Use to clear modem statistics.

Performance → Over The Air → Modem graph

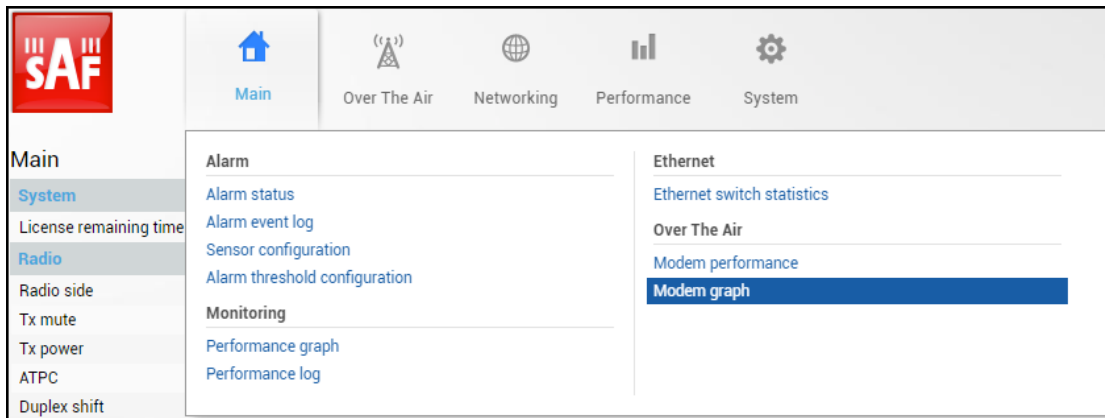

MODIFY button is deactivated in the Modem graph page.

The Modem graph can be activated in two modes – “constellation diagram” and “spectrum”.

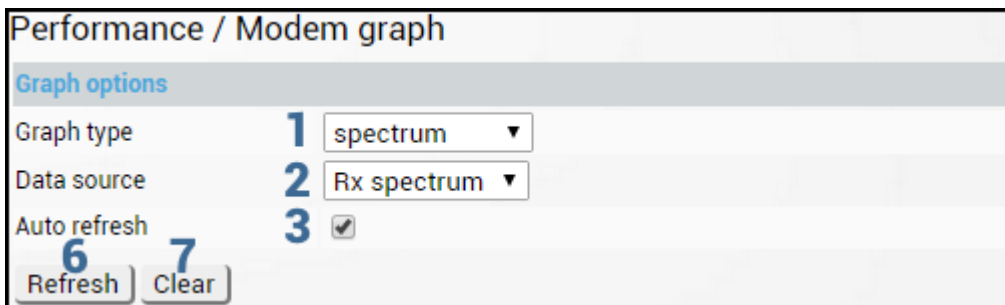
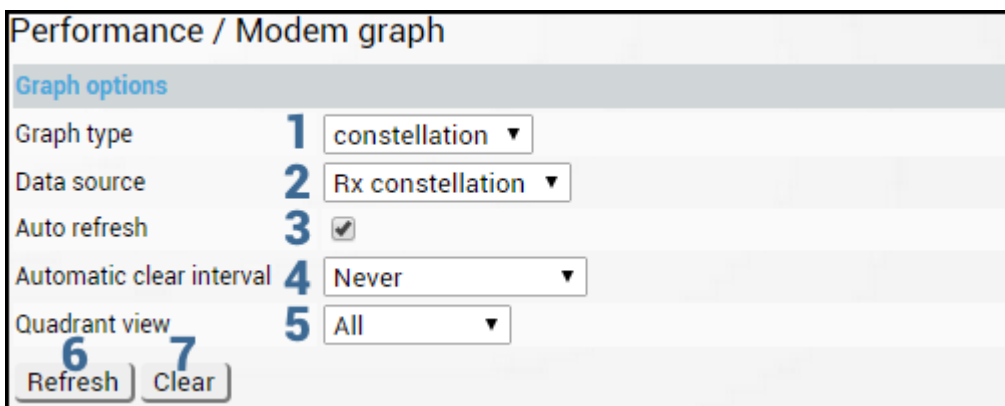

- 1) **Graph type** – Allows choosing between “constellation” and “spectrum” graph types.
- 2) **Data source** – Indicates source of the signal.
- 3) **Auto refresh** – Allows disabling auto refresh of constellation/spectrum.
- 4) **Automatic clear interval** – Allows choosing how often is constellation automatically cleared.
- 5) **Quadrant view** – Allows zooming constellation diagram to specific quadrant or part of the quadrant.
- 6) **Refresh** – Allows refreshing constellation diagram/spectrum. This button is not available if auto refresh enabled.
- 7) **Clear** – Allows clearing constellation diagram/spectrum.



Only a single user can see Constellation diagram and Spectrum curve at a time.

Constellation diagram

A constellation diagram is a representation of a signal modulated by the digital modulation schemes 1024QAM, 512QAM, 256QAM, 128QAM, 64QAM, 32QAM, 16QAM, 8QAM or 4QAM. It displays the signal as a two-dimensional scatter diagram in the complex plane at symbol sampling instants. Measured constellation diagram can be used to recognize the type of interference and distortion in a signal.

Constellation diagram (512QAM):

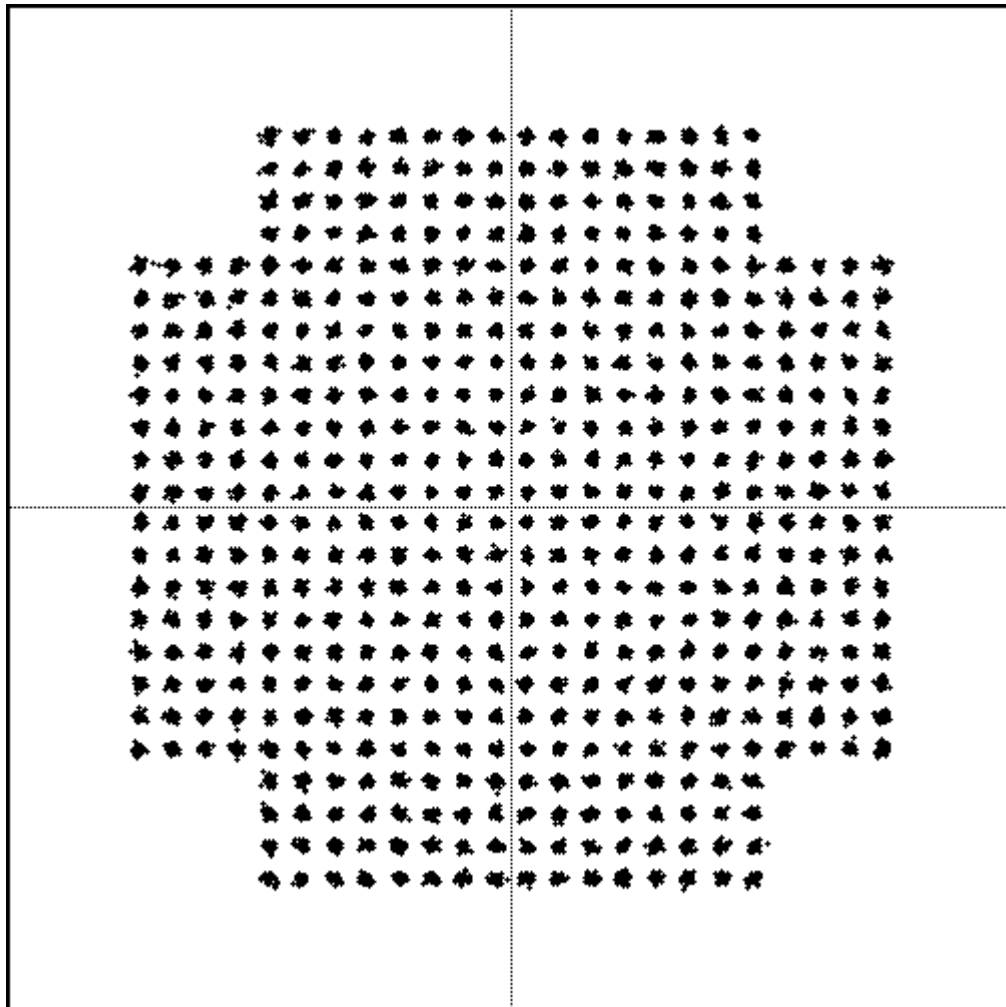

Examples of Integra-W/Integra-WS constellation diagrams under ideal conditions are shown below:

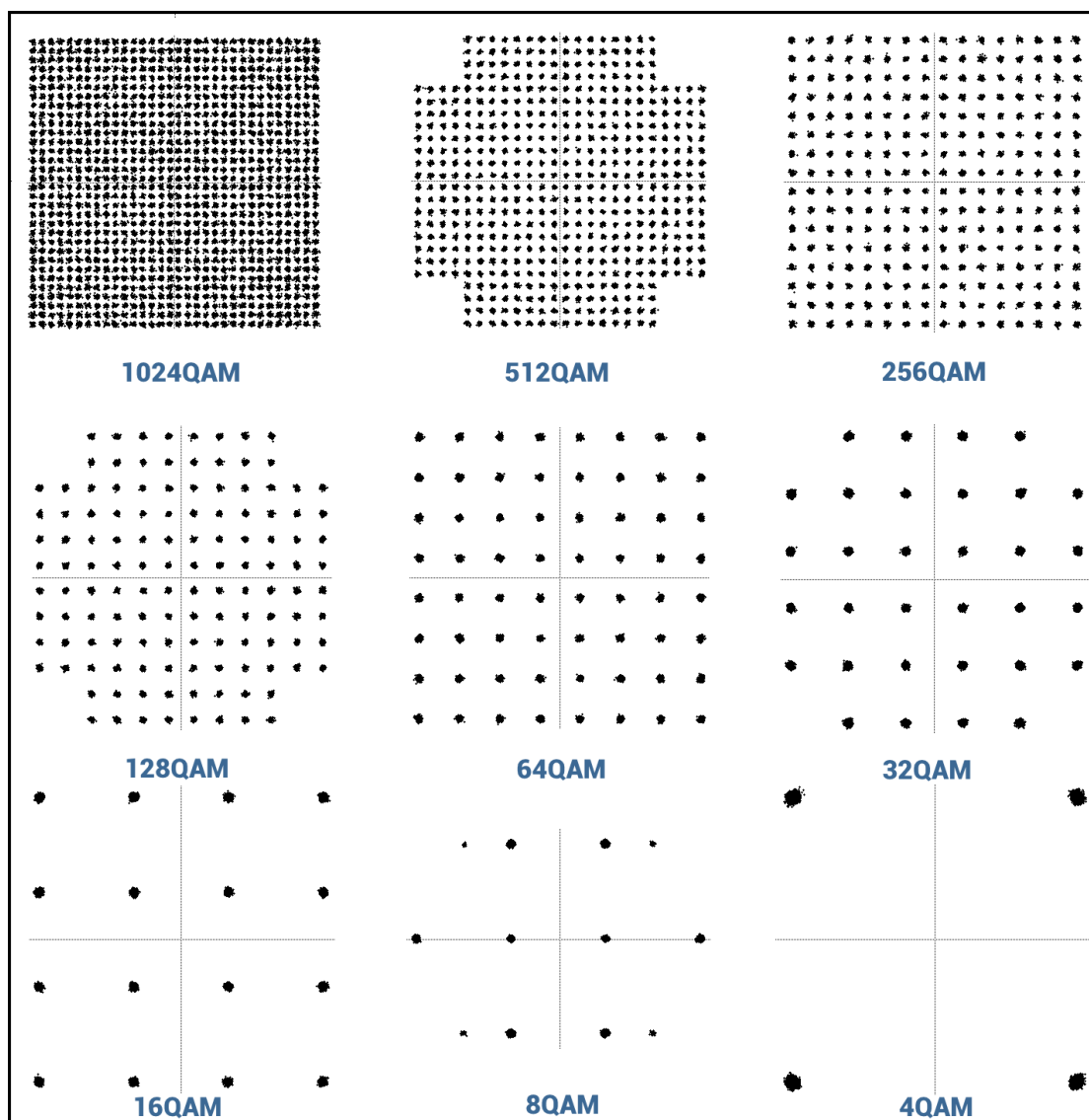

For the purpose of analyzing the received signal quality, some types of corruption are evident in the constellation diagram. For example:

- 1) Gaussian noise is displayed as fuzzy constellation points:

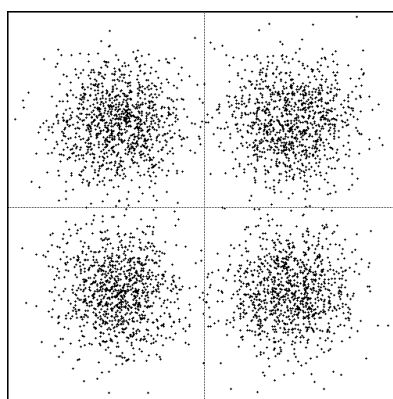

- 2) Non-coherent single frequency interference is displayed as circular constellation points:

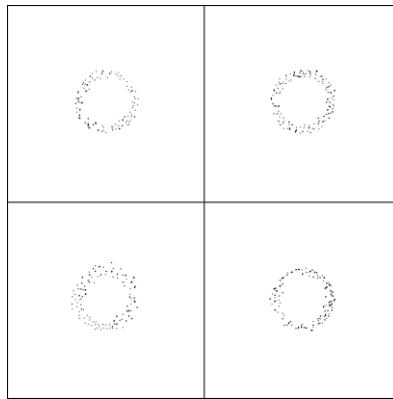

- 3) Phase noise is displayed as rotationally spreading constellation points:

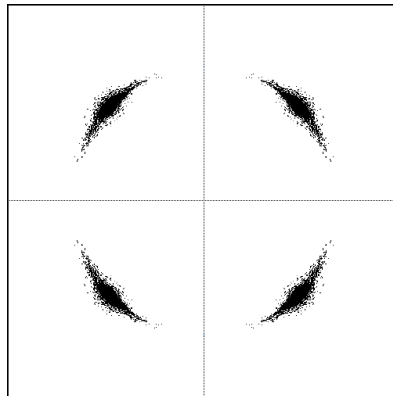

Spectrum

A spectrum curve is a representation received signal on the input of the modem. For this reason, spectrum signal levels will not correspond to actual radio receiver's signal level. The signal appearance will depend on configured channel bandwidth. Measured spectrum curve can be used to recognize in-band interference or very powerful out-band interference (due to filters applied).

Spectrum: (80MHz):

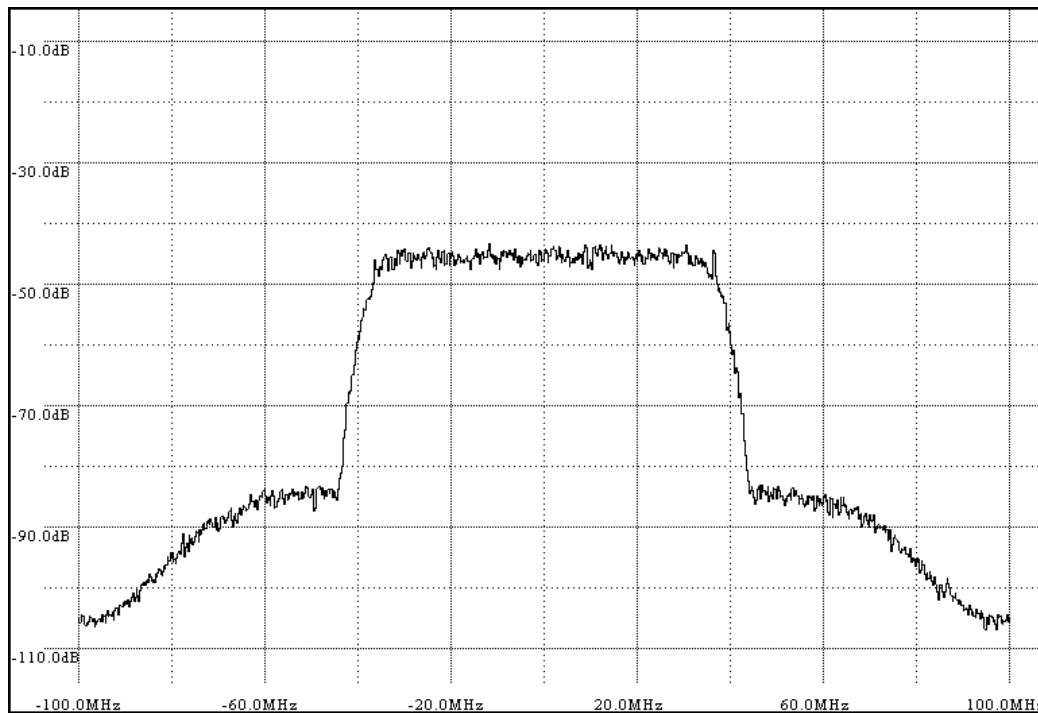

Examples of Integra-W/Integra-WS spectrum curves in various channel bandwidths:

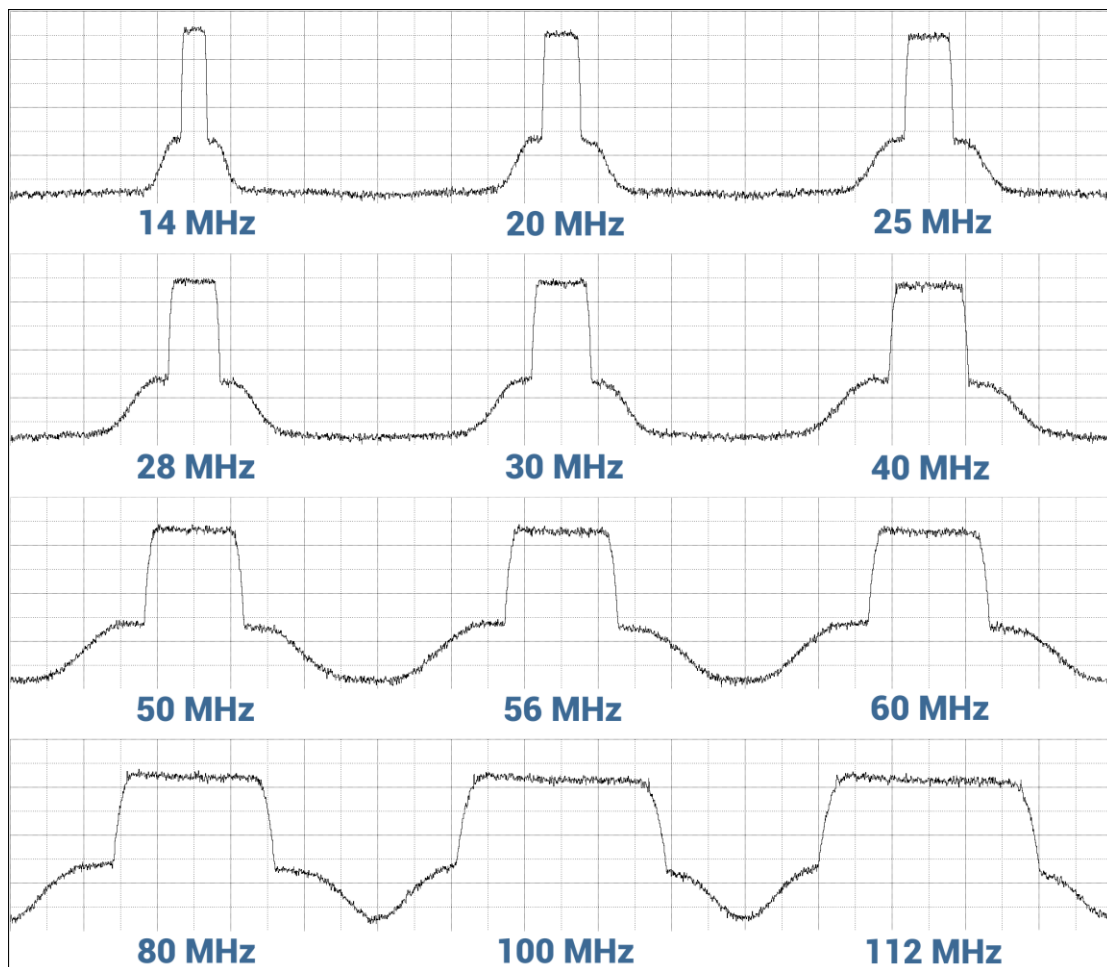

System

System → FW → Firmware upgrade

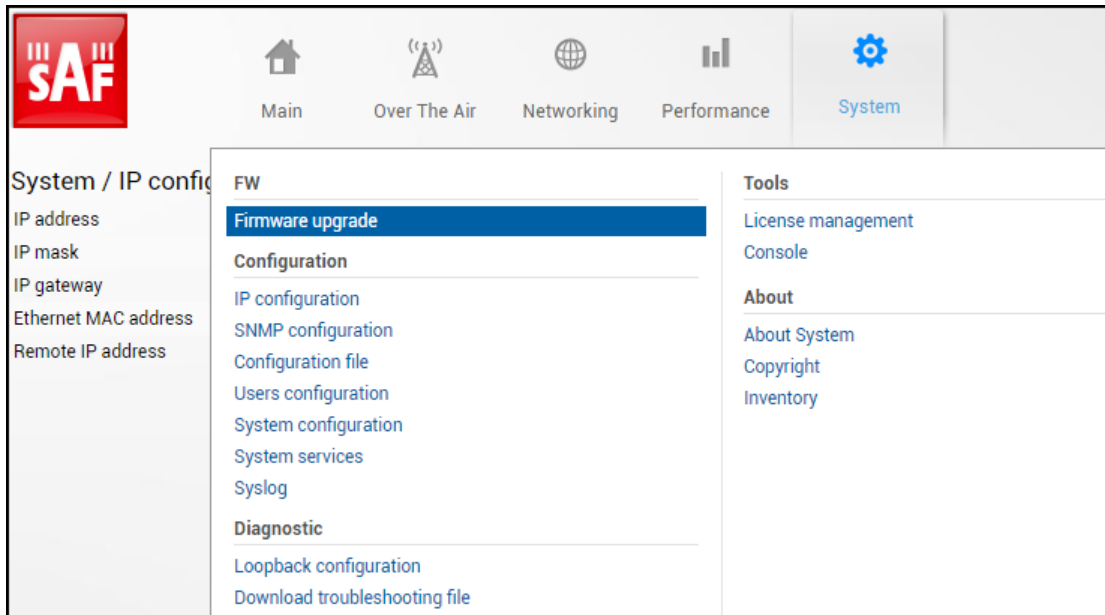

Status mode



Press MODIFY button.

Modify mode

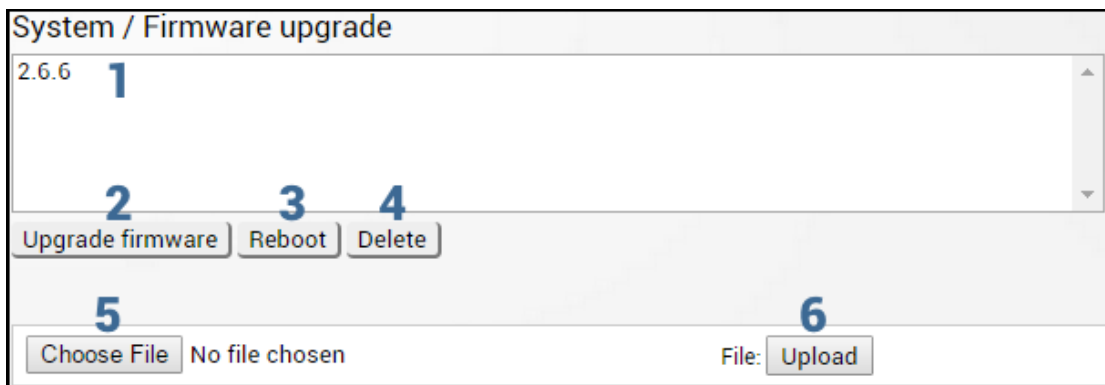

- 1) Shows list of available firmware files.
- 2) **Upgrade firmware** – click on preferred firmware in the list and press “Upgrade firmware” button to initiate firmware upgrade process.



Latest Integra-W/Integra-WS firmware can be downloaded in <https://saftehnika.com/en/downloads> in “Firmwares” section. Login required.

- 3) **Reboot** – Reboots Integra-W/Integra-WS (cold restart).
- 4) **Delete** – Deletes selected firmware file from the list.
- 5) **Choose File** – Press to browse for a firmware file on your hard disk drive.
- 6) **Upload** – Press to upload a firmware file to Integra-W/Integra-WS.

Integra series firmware upgrade via Web GUI

Firmware update package contains firmware file (.bin extension), release notes and firmware upgrade instructions.

Latest Integra firmware update package can be downloaded at the following URL: <https://www.saftehnika.com/en/downloads> (registration required).

The main method for firmware upgrade is upload via Web GUI, which automates the whole firmware upgrade process. To perform a software upgrade from Web GUI, please follow these steps:

- 1) Go to "System → FW → Firmware upgrade".
- 2) Press "MODIFY" button on right side of the page.
- 3) Press "Choose File" button, locate *.bin firmware file on your hard disk (extracted from the firmware update package) and press "Open" button.
- 4) Press "Upload" button.
- 5) Select uploaded firmware from firmware list and press "Upgrade firmware" button.
- 6) Confirm the upgrade and reboot the system.

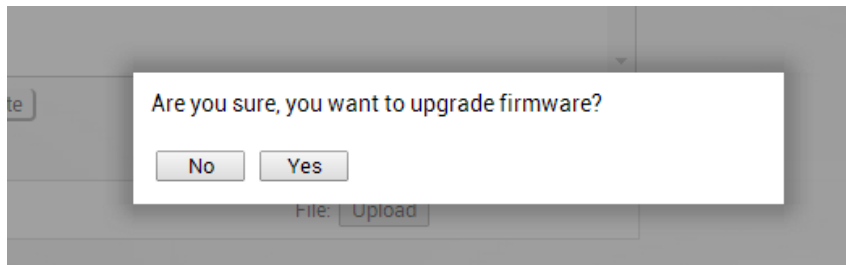

The remote side must be upgraded first.

Please do not unplug power until firmware upgrade procedure is finished - Web GUI will automatically reconnect and login page will appear.

Transition between out-band management and in-band management firmware versions

In-band management firmware version (3.xx.x-esw): management is available both on dedicated management (MM) port and on data (LAN) ports. User traffic is available only on data (LAN) ports.

Out-band management firmware version (3.xx.x-mux): management is available only on dedicated management (MM) port. User traffic is available only on one of the data (LAN) ports. By default – LAN (TP) is enabled, while LAN (SFP) is disabled.

Upgrading from out-band management (3.xx.x-mux) to in-band management (3.xx.x-esw) firmware version



Some HW revisions (without "S1" at the end of P/N) might have issues if FW version is changed from out-band management to in-band management.

- Follow instructions in the section Integra series firmware upgrade via Web GUI.
- A single Ethernet cable should be interconnected between Integra LAN port and CPE in order to avoid Ethernet loops.

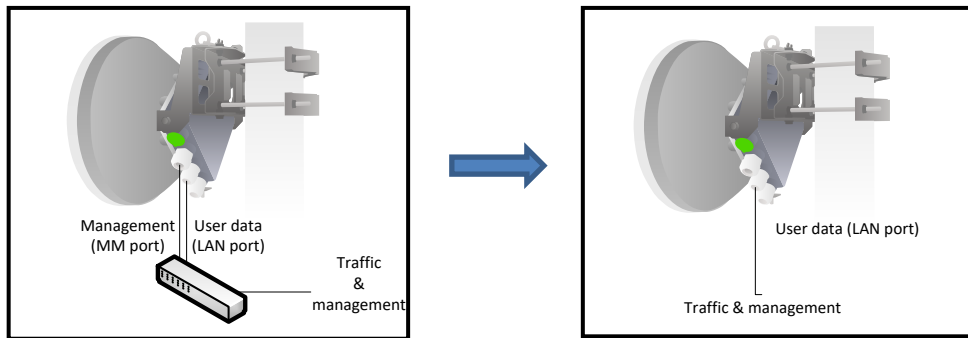

Upgrading from in-band management (3.xx.x-esw) to out-band management (3.xx.x-mux) firmware version

- Follow instructions in the section Integra series firmware upgrade via Web GUI.
- Management will be available only on dedicated management (MM) port, thus in order to maintain management access after the firmware upgrade, management (MM) port should be interconnected with CPE on one side of the link if management traffic is transmitted over the link (default setting). If management traffic is not transmitted over the link, management (MM) port should be interconnected with CPE on both sides of the link.

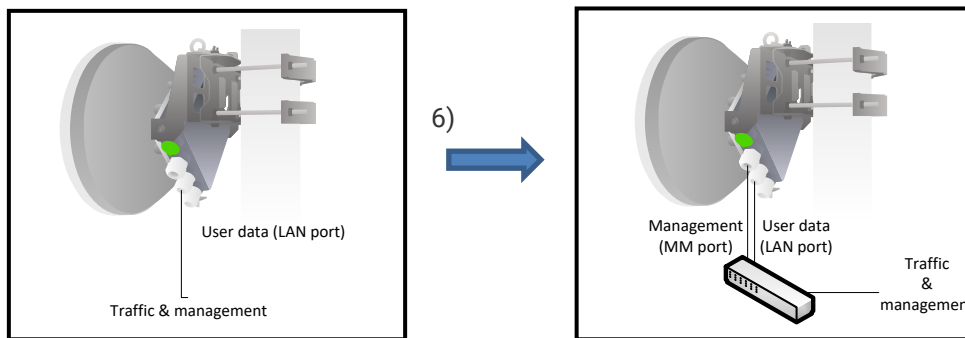

CLI commands (Chapter 4: COMMAND LINE INTERFACE)

firmware info [<version>]	Use to show detailed information on current or specific Integra-W/Integra-WS firmware.
firmware install <version>	Use to install firmware version uploaded. Note that exact version needs to be entered. Check available firmware versions using command "firmware list".
firmware list	Use to list uploaded firmware versions.
firmware remove <version>	Use to remove firmware version uploaded. Note that exact version needs to be entered. Check available firmware versions using command "firmware list".
firmware remove.list	Use to remove all uploaded firmware versions.
firmware switch	Use to check running firmware bank and bank that will be used at the next boot.
firmware {fs fw1 fw2 toggle} switch	Use to define bank that will be used at the next boot. "fw1" and "fw2" subcommands set appropriate bank, "toggle" forces to set another bank than the running one, "fs" is factory defined emergency bank, which is used if both "fw1" and "fw2" fail.
firmware upload <filename>	Use to upload firmware from the FTP directory.

System → Configuration → IP configuration

The IP address configuration page is available in the menu (System → Configuration → IP configuration).

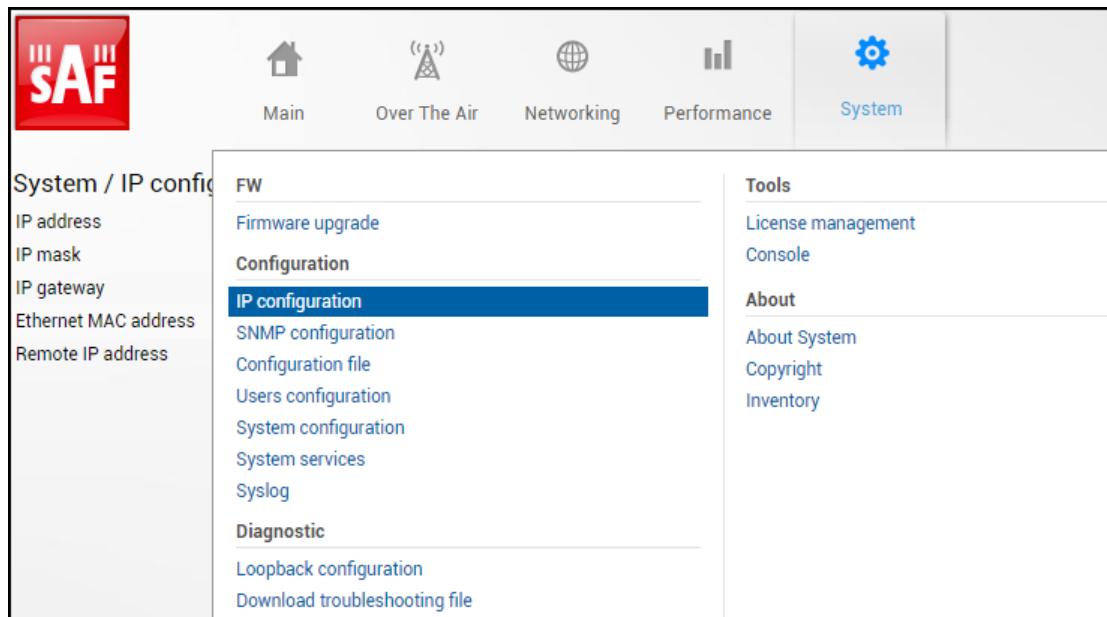

Status mode

System / IP configuration		
IP address	1	192.168.205.11
IP mask	2	255.255.255.0
IP gateway	3	192.168.205.1
Ethernet MAC address	4	00:04:a6:81:31:22
Remote IP address	5	192.168.205.10 <input checked="" type="checkbox"/> Auto

Press MODIFY button.

Modify mode

System / IP configuration		
IP address	1	<input type="text" value="192.168.205.11"/>
IP mask	2	<input type="text" value="255.255.255.0"/>
IP gateway	3	<input type="text" value="192.168.205.1"/>
Ethernet MAC address	4	00:04:a6:81:31:22
Remote IP address	5	192.168.205.10 <input checked="" type="checkbox"/> Auto
		6 <input type="button" value="Execute configuration"/>

- 1) **IP address** – Indicates IP address of Integra-W/Integra-WS you are currently logged in (status mode); allows specifying IP address of Integra-W/Integra-WS you are currently logged in (modify mode). Default IP address is 192.168.205.10 or 192.168.205.11 – depending on which side the specific Integra-W/Integra-WS is – low side has 192.168.205.10 IP address and high side – 192.168.205.11.



Integra-W/Integra-WS IP addresses need to be on the same subnet.

- 2) **IP Mask** – Indicates IP mask of Integra-W/Integra-WS you are currently logged in (status mode); allows specifying IP mask of Integra-W/Integra-WS you are currently logged in (modify mode). Default IP mask is 255.255.255.0.

- 3) **IP gateway** – Indicates gateway address of Integra-W/Integra-WS you are currently logged in (status mode); allows specifying gateway address of Integra-W/Integra-WS you are currently logged in (modify mode). By default, gateway is not specified (blank).
- 4) **Ethernet MAC address** – shows the MAC address of Integra-W/Integra-WS you are currently connected to.
- 5) **Remote IP address** – shows IP address of remote (far-end) Integra-W/Integra-WS. By default, remote IP address is being retrieved automatically and therefore “Auto” checkbox is selected. In modify mode you can unselect “auto” option and enter remote IP address manually.
- 6) By pressing „Execute configuration” changes made to the corresponding section apply only to the local side Integra-W/Integra-WS.

CLI commands (Chapter 4: COMMAND LINE INTERFACE)

system ip addr [<IP>]	Use to show/set IP address of management CPU.
system ip gw [{<IP> clear}]	Use to show/manage IP address of the gateway.
system ip mask [<mask>]	Use to show/set subnet mask.
System ip mac	Use to show MAC address of management CPU.
System ip cfg {<ip address> <mask> <ip address> <mask> <gateway> <ip address/CIDR> <ip address/CIDR> <gateway>}	Use to set IP address and subnet or optionally IP address, subnet mask and gateway simultaneously.
system remoteip show	Use to show remote IP address.
system remoteip auto	Use to set automatic retrieving of remote IP address.
system remoteip set <IP>	Use to define remote IP address (deactivates automatic retrieving of remote IP address).
system diag ping <IP_address>	Use to ping an IP address.

System → Configuration → SNMP configuration

The SNMP configuration pages provide configuration of SNMP communities, host and trap addresses. SAF NMS system will work only when SNMP is properly configured.

 Relevant MIB files can be downloaded directly from Integra-W/Integra-WS Web GUI. See (7) below.

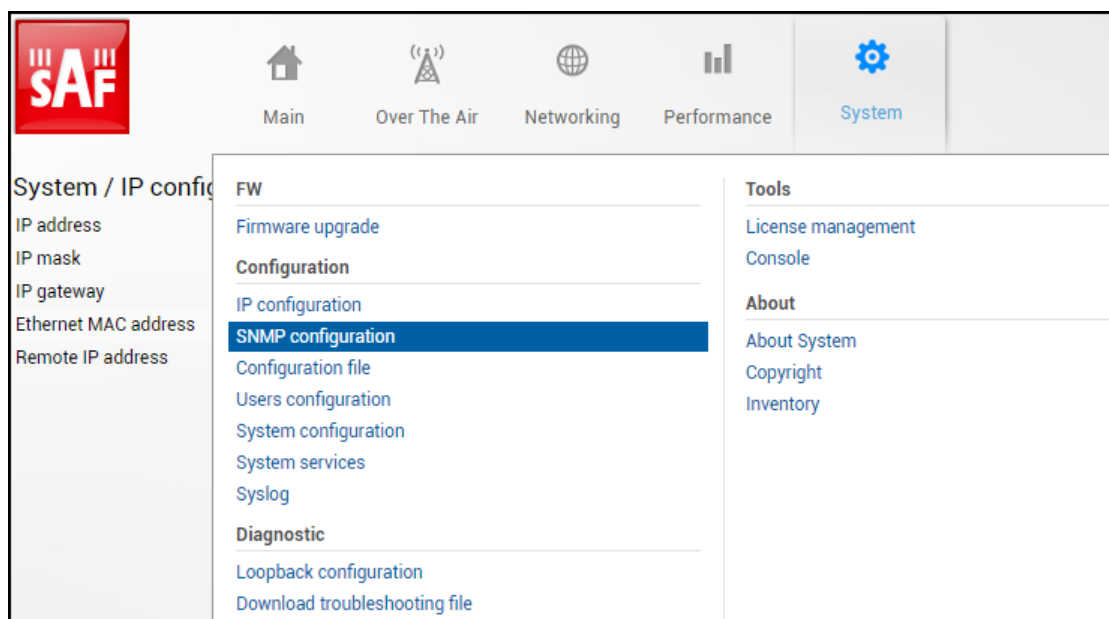

SNMPv1/v2c setup

Status mode

System / SNMP configuration

SNMPv1/v2c setup	SNMPv3 setup	
Read community	1	saf-public
Write community	2	saf-private
Trap community	3	saf-traps
List of SNMP managers	4	192.168.1.92
List of trap v1 managers	5	192.168.205.240
List of trap v2c managers	6	192.168.100.207

[Download MIB file](#) **7**

Press **MODIFY** button.

Modify mode

System / SNMP configuration

SNMPv1/v2c setup	SNMPv3 setup	
Read community	1	<input type="text" value="saf-public"/>
Write community	2	<input type="text" value="saf-private"/>
Trap community	3	<input type="text" value="saf-traps"/>
List of SNMP managers	4	<input type="text" value="192.168.1.92"/>
		<input type="text"/>
		<input type="button" value="Add"/> <input type="button" value="Delete"/>
List of trap v1 managers	5	<input type="text" value="192.168.205.240"/>
		<input type="text"/>
		<input type="button" value="Add"/> <input type="button" value="Delete"/>
List of trap v2c managers	6	<input type="text" value="192.168.100.207"/>
		<input type="text"/>
		<input type="button" value="Add"/> <input type="button" value="Delete"/>

[Download MIB file](#) **7** **8**

- 1) **Read community** – Indicates currently specified read community for SNMPv1/v2c (status mode); allows specifying read community for SNMPv1/v2c of the agent to enable parameters to be read (modify mode). The default read community name is “saf-public”.
- 2) **Write community** – Indicates currently specified write community for SNMPv1/v2c (status mode); allows specifying write community for SNMPv1/v2c of the agent to

enable parameters to be written (modify mode). The default write community name is "saf-private".

- 3) **Trap community** – Indicates currently specified trap community for SNMPv1/v2c (status mode); allows specifying trap community for SNMPv1/v2c for trap authentication in monitoring applications (modify mode). The default trap community name is "saf-traps".
- 4) **List of SNMP managers** – Shows the list of configured SNMPv1/v2c host IP addresses (status mode); allows adding/deleting SNMPv1/v2c host IP addresses (modify mode). Specified IP addresses have access to read and modify configuration parameters using the appropriate read-and-write community names.
- 5) **List of trap v1 managers** – Shows a list of configured SNMPv1 trap IP addresses (status mode); allows adding/deleting SNMPv1 trap IP addresses (modify mode). The Integra-W/Integra-WS management controller sends SNMPv1 traps to the Trap Manager with the IP address specified here.
- 6) **List of trap v2c managers** – Shows a list of configured SNMPv2c trap IP addresses (status mode); allows adding/deleting SNMPv2c trap IP addresses (modify mode). The Integra-W/Integra-WS management controller sends SNMPv2c traps to the Trap Manager with the IP address specified here.
- 7) **Download MIB file** – Click to download Integra-W/Integra-WS MIB files.
- 8) By pressing „Execute configuration“, changes made to the corresponding section apply only to the local side Integra-W/Integra-WS.

SNMPv3 setup

SNMPv3 primarily is improved with security settings. It does not rely on SNMP community names as it is in versions 1 and v2c.

Status mode

System / SNMP configuration

SNMPv1/v2c setup **SNMPv3 setup**

SNMPv3 users

User name	Authentication password	Privacy password	Authentication	Encryption	Access
safuser	1	SHA-1	AES-128	read

SNMPv3 security settings **11**

Security level authPriv

Download MIB file **12**

Press  **MODIFY** button.

snmp syscontact <syscontact>	Use to show/set system contact.
snmp traps trap-community {set del} <trap-community>	Use to show/set/delete trap community name.
snmp traps trapv1manager {add delete} <trapv1manager>	Use to show/add/delete v1 trap manager IP address.
snmp traps trapv2manager {add delete} <trapv2manager>	Use to show/add/delete v2c trap manager IP address.
snmp v3 user {add del} <v3user> <authpass> <privpass> {r w} {SHA-1 SHA-224 SHA-256 SHA-384 SHA-512} {DES AES-128 AES-192 AES-256}	Use to show/add/delete v3 username with the corresponding authentication password, encryption password, read or write access level, authentication protocol and data encryption protocol.

System → Configuration → Configuration file

Shows saved and running configurations, highlighting differences between both (unsaved changes).

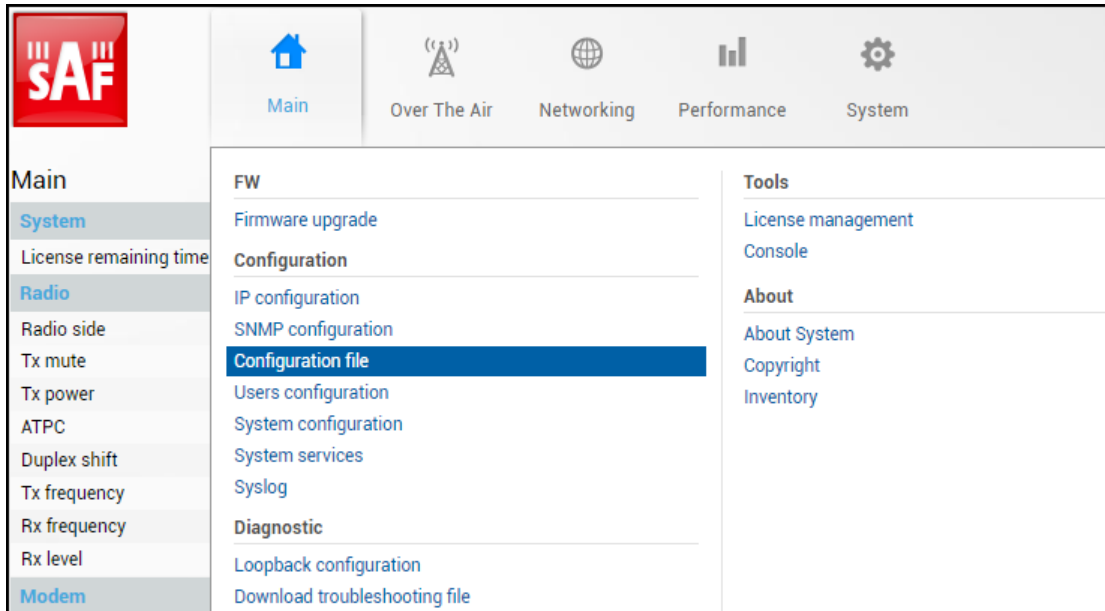

Status mode

System / Configuration file

Advanced cfg file features

Download saved configuration file

Restore configuration from file

Restore configuration from saved configuration file

Restore factory configuration file

Compare saved / running configurations

Saved configuration 6	7 Running configuration
<pre>{ evlogd: {}, snmpd: {}, perfd: {}, i2cd: {}, sysd: {}, modem: { version: "1", name: "80_MHz", profiles: "0x0020", }, modulations: [], }, network: {}, radio: {}, lspd: {} }</pre>	<pre>{ evlogd: {}, snmpd: {}, perfd: {}, i2cd: {}, sysd: {}, modem: { version: "1", name: "60_MHz", profiles: "0x0001", }, modulations: [], }, network: {}, radio: {}, lspd: {} }</pre>

Press **MODIFY** button.

Modify mode

System / Configuration file

Advanced cfg file features

Download saved configuration file **1**

Restore configuration from file All ▾ from **2** Choose File No file chosen **3**

Restore configuration from saved configuration file **4**

Restore factory configuration file **5**

Compare saved / running configurations

Saved configuration 6	7 Running configuration
<pre>{ evlogd: {}, snmpd: {}, perfd: {}, i2cd: {}, sysd: {}, modem: {}, network: {}, radio: {}, lspd: {} }</pre>	<pre>{ evlogd: {}, snmpd: {}, perfd: {}, i2cd: {}, sysd: {}, modem: {}, network: {}, radio: {}, lspd: {} }</pre>

- 1) **Download** – Press to download **saved** system configuration txt file and store it on your hard drive.

- 2) **Choose File** – Press to browse for a previously saved configuration file on your hard disk drive.
- 3) **Cfg import** – Press to upload a configuration file to Integra-W/Integra-WS.



Uploaded configuration overwrites the saved configuration.

- 4) **Cfg restore** – Press to restore saved system configuration, i.e., unsaved changes will be discarded!



Restoring configuration overwrites running configuration with the saved configuration.

- 5) **Cfg factory** – Resets system configuration to factory defaults.
- 6) **Saved configuration** – Shows saved system configuration.
- 7) **Running configuration** – Shows currently running system configuration.



Distinct sections in saved and running configurations are highlighted with color. In order to examine particular differences, expand highlighted sections of configuration by clicking on down arrow of the appropriate configuration section.

CLI commands (Chapter 4: COMMAND LINE INTERFACE)



It is highly recommended to use the CLI command 'configuration browse' only after the SSH connection is established.

configuration browse {<name> running saved}	Use to show one of the last 10 configurations, running or saved configuration.
configuration download	Use to create a copy of the saved configuration file as a txt file in the FTP directory.
configuration factory	Use to reset system configuration to factory defaults.
configuration factory i2cd	Use to reset configuration of i2cd settings to factory defaults.
configuration factory modem	Use to reset modem configuration to factory defaults.
configuration factory netsys {mac-table port-state}	Use to reset whole Ethernet configuration to factory defaults or particular sections using subcommands – “mac-table” for MAC table; “port-state” for port state configuration; “qos” for QoS configuration; “rate” for rate limit configuration; “vlan” for VLAN configuration.
configuration factory sysd	Use to reset the whole system configuration to factory defaults.
configuration import {All} <preset name>	Use to restore the configuration from a txt file stored in the FTP directory.
configuration load	Use to restore saved system configuration, i.e., unsaved changes will be discarded!
configuration status	Use to check whether the running configuration is saved.
configuration store	Use to save the running configuration.
configuration watch	Use to show entities watch status.

System → Configuration → Users configuration

Integra-W/Integra-WS features 2 default user accounts – *admin* (full control) and *guest* (read-only).

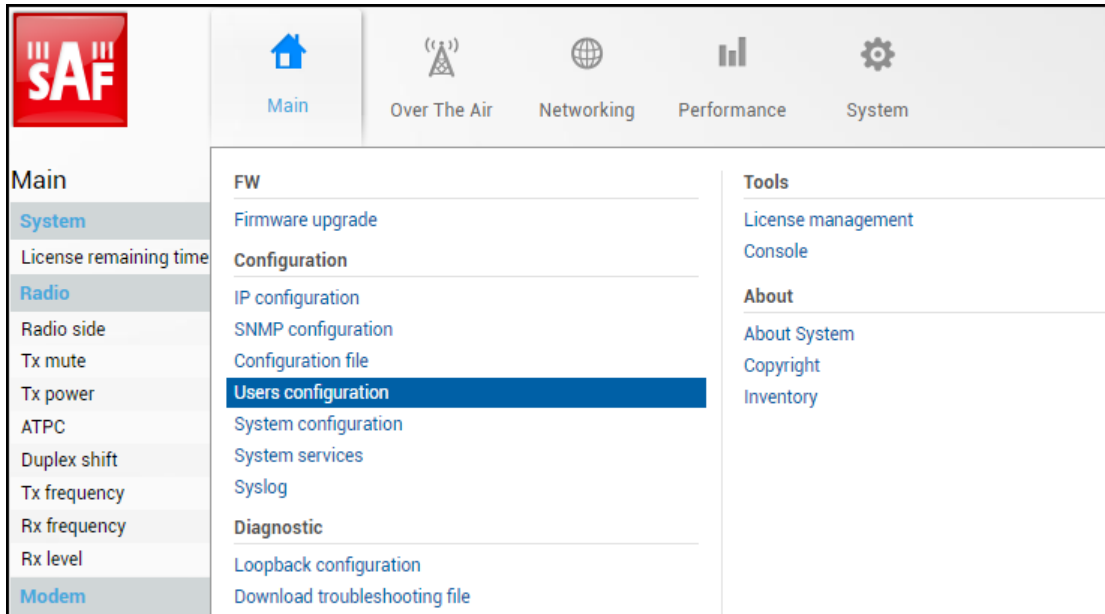

Status mode



Press MODIFY button.

Modify mode

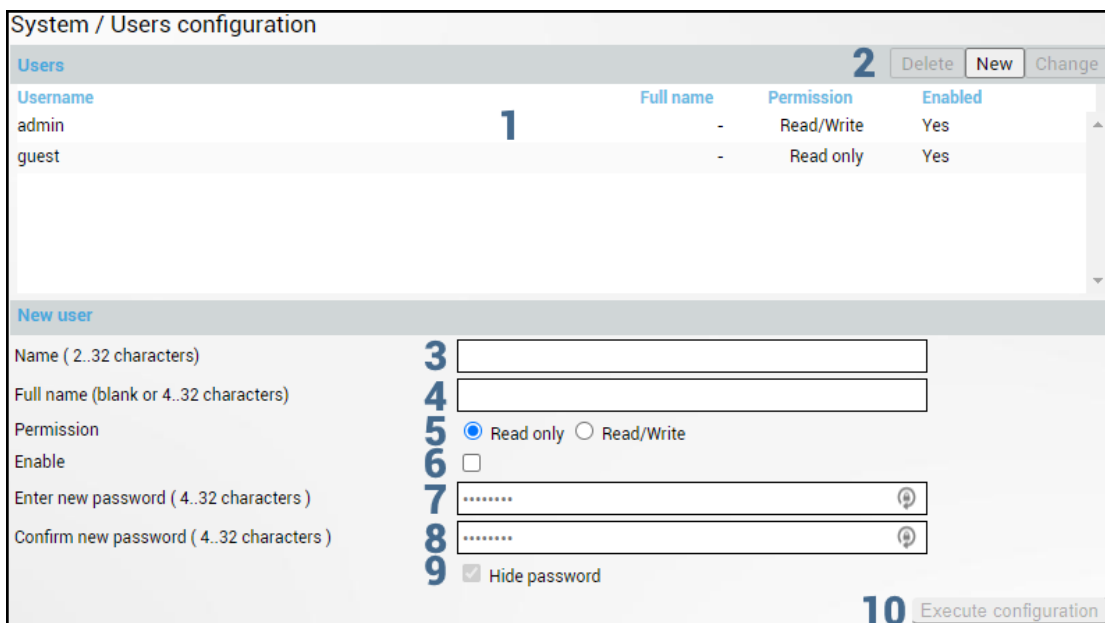

- 1) **Users** – Shows the list of available users (Username), full name (if specified), permissions, and whether the user is active (enabled).

- 2) Press “New” to create a new user or click on a user from the list and choose to modify (Change) or delete the user (Delete).

New user / Selected user

- 3) **Name (2..32 characters)** – Enter a user name. The length is between 2 and 32 characters.
- 4) **Full name (4..32 characters)** – Enter the full name of the user (New user) or modify the existing user’s name. The length is between 4 and 32 characters.
- 5) **Permission** – Select read-only or read/write permissions. A user with “read/write” permissions can change the configuration, while a user with read-only permissions can monitor link status only.
- 6) **Enable** – Enable or disable the user.
- 7) **Enter new password (4..32 characters)** – Enter a new password. The length is between 4 and 32 characters.
- 8) **Confirm new password (4..32 characters)** – Confirm new password. The length is between 4 and 32 characters.
- 9) **Hide password** – Uncheck to display the entered password in plaintext.
- 10) By pressing „Execute configuration”, changes made to the corresponding section apply only to the local side Integra-W/Integra-WS.

 By default, the password for the “admin” account is ‘changeme’, while no password is defined for the “guest” account (user disabled).

CLI commands (Chapter 4: COMMAND LINE INTERFACE)

system user info	Use to show information on the current user.
system user mgmt <username> access {r w}	Use to set read (“r”) or write (“w”) access right for particular <username>.
system user mgmt <username> delete	Use to delete particular <username>. “admin” user cannot be deleted.
system user mgmt <username> {enable disable}	Use to enable or disable particular <username>.
system user mgmt <username> info	Use to show information on particular <username>.
system user mgmt <username> password <password>	Use to set password for particular <username>.
system user new <username> <password> {r w} <fullname>	Use to create new user with specified <username>, <password>, <fullname> and read (“r”) or write (“w”) permissions.
system user factory	Use to reset all users to factory defaults.
system password change <password>	Use to change the password for the current user.
system password reset	Use to reset all passwords to default.

System → Configuration → System configuration

Specify DNS servers, time settings, and system/location names.

DNS servers have to be added before adding domain names to the NTP list.

Status mode

System / System configuration

System configuration

System name (<= 32 characters)	1	IntG STUDIO
Location name (<= 64 characters)	2	Riga 1
Timezone	3	UTC+03:00
Time (YY-MM-DD hh:mm:ss)	4	2022-01-28 14:44:44

DNS setup

List of DNS servers	6	8.8.8.8
	7	<input type="text"/>
		<input type="button" value="Resolve"/>

NTP setup

NTP client	8	Enabled
List of NTP servers	9	1.pool.ntp.org

Press  **MODIFY** button.

Modify mode

System / System configuration

System configuration

System name (<= 32 characters) **1**

Location name (<= 64 characters) **2**

Timezone **3**

Time (YY-MM-DD hh:mm:ss) **4** **5**

DNS setup

List of DNS servers **6**

NTP setup

NTP client **8** Enable

List of NTP servers **9**

10

11

- 1) **System name** – Allows entering a preferable system name. The maximum length of the system name cannot exceed 32 symbols. The default name is ‘SAF’.
- 2) **Location name** – Allows entering preferable system location name. The maximum length of the location name cannot exceed 64 symbols. By default, the system location is not specified.
- 3) **Timezone** – Allows specifying the time zone.
- 4) **Time (YY-MM-DD hh:mm:ss)** – Allows changing system date and time manually by entering date and time in a specific syntax.
- 5) **Set local machine time** – Press to force the system to use the time set on your PC, from which you are connected to the Web GUI.
- 6) **List of DNS servers** - Allows adding or deleting IP addresses of DNS servers.
- 7) Possibility to resolve domain names to check if DNS requests are working.
- 8) **NTP client** – Allows enabling or disabling the NTP (Network Time Protocol) client.
- 9) **List of NTP servers** – Allows adding or deleting IP addresses or domain names of NTP servers.
- 10) **Obtain time from NTP server** – Press to force the system to obtain the time from an NTP server.
- 11) By pressing „Execute configuration”, changes made to the corresponding section apply only to the local side Integra-W/Integra-WS.

CLI commands (Chapter 4: COMMAND LINE INTERFACE)

system datetime <datetime>	Use to show/set system time and date. Use “YYYY-MM-DD/hh:mm:ss” syntax for date/time.
system discovery clear	Use to clear device surroundings
system discovery list	Use to show the list of found devices using discovery protocol

system discovery refresh	Use to refresh device surroundings
system discovery remote <dst> <bcast>	Use to perform remote discovery using specified IP address and broadcast IP address
system dns dig <domain name>	Use to resolve a domain using configured DNS servers.
system dns server {add <DNSip> clear remove <DNSip>}	Use to add/remove DNS server with a specified IP address or to remove all DNS servers from a list.
system dns status	Use to show configured DNS servers` list.
system location <location>	Use to show/define system location.
system name <sysname>	Use to show/define system name.
system ntp {enable disable}	Use to enable or disable NTP client.
system ntp server {add <NTPip> clear remove <NTPip>}	Use to add/remove NTP server with a specified IP address/hostname or to remove all NTP servers from a list.
system ntp status	Use to show NTP status and configured NTP servers` list.
system ntp sync	Use to force the system to obtain the time from an NTP server.
system ntp timezone <-12:00 ... 14:00>	Use to show/define UTC time zone (for example '2' for UTC+2 and '-3:30' for UTC-3:30).
system uptime	Use to show system uptime since the last system start.

System → Configuration → System services

Define Web GUI connection parameters and centralized user management (RADIUS). Refer to Chapter [RADIUS authentication](#) for an example of RADIUS configuration.

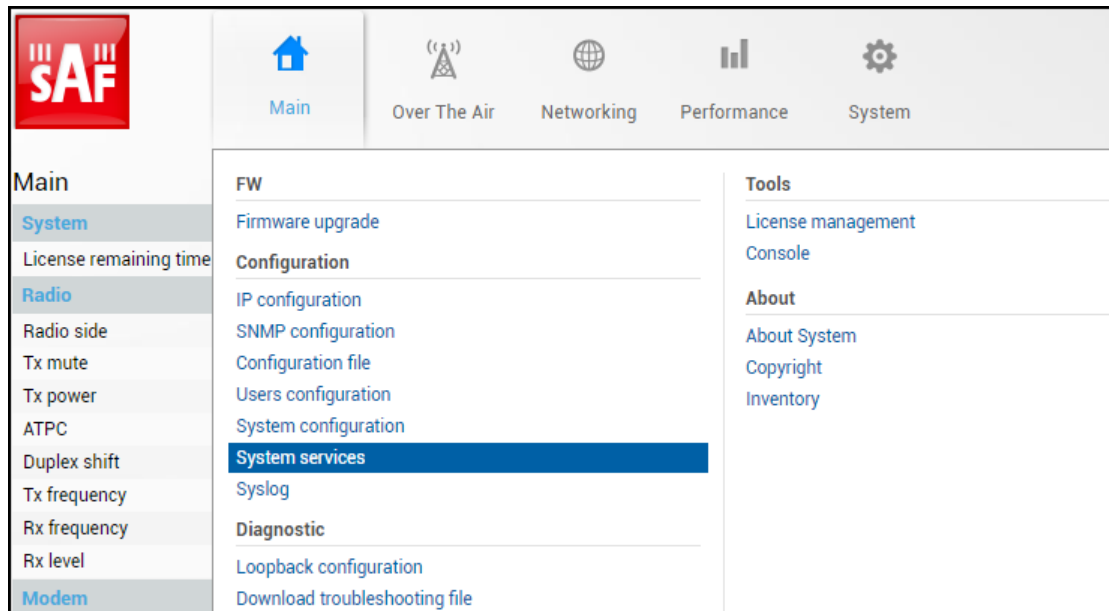

Status mode

System / System services		WEB service port configuration	
HTTP	1	Enabled	
HTTP port	2	80	
HTTPS	3	Enabled	
HTTPS port	4	443	
Redirect HTTP to HTTPS	5	Disabled	
HTTPS certificate state	6	Internal	
		RADIUS server configuration	
RADIUS	8	Disabled	
RADIUS port	9	1812	
RADIUS server IP address	10		
		SSH server configuration	
SSH	14	Enabled	
SSH Port	15	22	
SSH Login banner	16	_nnnn_ dGGGGMMb , @p~qp~qMb Linux Rules! M @ @) M @,----JM -' JS^_ / qKL dZP qKRb dZP qKkb fZP SM	
		Telnet server configuration	
Telnet	17	Disabled	
Telnet port	18	23	

Press  **MODIFY** button.

Modify mode

System / System services		WEB service port configuration	
HTTP	1	<input checked="" type="checkbox"/> Enable	
HTTP port	2	<input type="text" value="80"/>	
HTTPS	3	<input checked="" type="checkbox"/> Enable	
HTTPS port	4	<input type="text" value="443"/>	
Redirect HTTP to HTTPS	5	<input type="checkbox"/> Enable	
HTTPS certificate state	6	Internal	
HTTPS certificate (PEM)	7	<input type="text"/>	
		RADIUS server configuration	
RADIUS	8	<input checked="" type="checkbox"/> Enable	
RADIUS port	9	<input type="text" value="1812"/>	
RADIUS server IP address	10	<input type="text"/>	
Set RADIUS secret (<33 characters)	11	<input type="text" value="....."/>	
Confirm RADIUS secret (<33 characters)	12	<input type="text" value="....."/>	
Hide password <input checked="" type="checkbox"/>	13		
		SSH server configuration	
SSH	14	<input checked="" type="checkbox"/> Enable	
SSH Port	15	<input type="text" value="22"/>	
SSH Login banner	16	<input type="text" value="_nnnn_ dGGGGMMb , @p~qp~qMb Linux Rules! M @ @) M @,----JM -' JS^_ / qKL dZP qKRb dZP qKkb fZP SM"/>	
		Telnet server configuration	
Telnet	17	<input type="checkbox"/> Enable	
Telnet port	18	<input type="text" value="23"/>	
		19	20
		<input type="button" value="Reboot"/>	<input type="button" value="Execute configuration"/>

- 1) **HTTP** – allows disabling or enabling HTTP access to Web GUI. By default HTTP access is enabled.
- 2) **HTTP port** – allows specifying TCP port for Web GUI access via HTTP. By default, TCP port 80 is defined.
- 3) **HTTPS** – allows disabling or enabling HTTPS access to Web GUI. By default HTTPS access is enabled.

 By disabling both HTTP and HTTPS you will lose possibility to connect to the Web GUI.

- 4) **HTTPS port** – allows specifying TCP port for Web GUI access via HTTPS. By default, TCP port 443 is defined.

- 5) **Redirect HTTP to HTTPS** – allows enabling automatic redirecting from HTTP to HTTPS.
- 6) **HTTPS certificate state** – shows what type of SSL certificate is used on the device for HTTPS connections. There can be 2 types of SSL certificates:
 - a. *User* – user own uploaded and configured SSL certificate for HTTPS connections.
 - b. *Internal* – factory default firmware compiled SSL certificate for HTTPS connections. If a user's SSL certificate is uploaded and configured for HTTPS connections, then the device will first try to use this certificate. In case Integra for some reason can't use the User certificate and there are any errors in the User certificate usage process, then Integra will use the Internal certificate for HTTPS connections.
- 7) **HTTPS certificate (PEM)** – user can paste PEM format textual encoding of SSL certificate in this field and then the device will use this SSL certificate for HTTPS connections.
- 8) **RADIUS** - allows enabling or disabling RADIUS (Remote Authentication Dial-In User Service) server authentication for device access. By default, RADIUS server usage is disabled.
- 9) **RADIUS port** – allows specifying a port for RADIUS server access. By default, port 1812 is defined.
- 10) **RADIUS server IP address** – allows specifying RADIUS server IP address.
- 11) **Set RADIUS secret** – allows specifying RADIUS server password.
- 12) **Confirm RADIUS secret** – used for confirmation of RADIUS server password.
- 13) **Hide password** - uncheck to see the entered RADIUS server password in plain text.
- 14) **SSH** - allows enabling or disabling SSH service on the device.
- 15) **SSH Port** – allows selecting a port number for SSH service.
- 16) **SSH Login banner** – allows to enter a textual banner message that will be shown when a user will try to login to the device via SSH connection.
- 17) **Telnet** – allows enabling or disabling Telnet service on the device.
- 18) **Telnet port** - allows selecting a port number for Telnet service.
- 19) **Reboot** – allows rebooting the Integra-W/Integra-WS device (cold restart).
- 20) By pressing „**Execute configuration**” changes made in this section will be applied to the local side Integra device. It is not possible to apply these settings to devices on both sides at the same time and changes need to be made on each side separately.

CLI commands (Chapter 4: COMMAND LINE INTERFACE)

system service HTTP {enable disable}	Use to show status or enable/disable HTTP service.
system service HTTP port <port>	Use to show/change the port number for HTTP service.
system service HTTPS {enable disable}	Use to show status or enable/disable HTTPS service.
system service HTTPS port <port>	Use to show/change the port number for HTTPS service.
system service HTTPS ssl_cert import <cert>	Allows to import and configure SSL certificate in PEM format, previously uploaded to device memory via FTP, for usage on further HTTPS connections.

system service HTTPS ssl_cert reset	Allows to stop the usage of previously uploaded and imported user own SSL certificates and configures the device to use its own Internal SSL certificate.
system service ftp {enable disable}	Use to show status or enable/disable FTP service.
system service redirect {enable disable}	Use to show status or enable/disable HTTP redirection to HTTPS.
system service ssh banner {clear set <banner text> show}	Use to clear/set/show SSH login (1-255 characters long) banner.
system service ssh {enable disable}	Use to enable/disable SSH service.
system service ssh port {set <port> reset show}	Use to set/reset/show a port number of SSH service. By default, port 22 is defined.
system service ssh status	Use to show the status of SSH service.
system service status	Use to show service ports configuration.
system service telnet {enable disable}	Use to enable/disable TELNET service.
system service telnet port {reset set <port> show}	Use to reset/set/show a port number of TELNET service. By default, port 23 is defined.
system service telnet status	Use to show the status of the TELNET service.
system service telnet-client <IP_address>	Use to connect to a remote Integra with the specified IP address. (This command is not supported in Web Console).
system radius addr <IP_address>	Use to define RADIUS server IP address.
system radius {enable disable}	Use to enable/disable RADIUS configuration.
system radius port <port>	Use to define a port number (0..65535) of a RADIUS server. By default, port 1812 is defined.
system radius secret <secret>	Use to define a RADIUS server password (less than 33 characters long).
system radius status	Use to show RADIUS configuration status.

System → Configuration → Syslog

Integra-W/Integra-WS supports the Syslog standard for system management message logging and sending to a monitoring Syslog server.

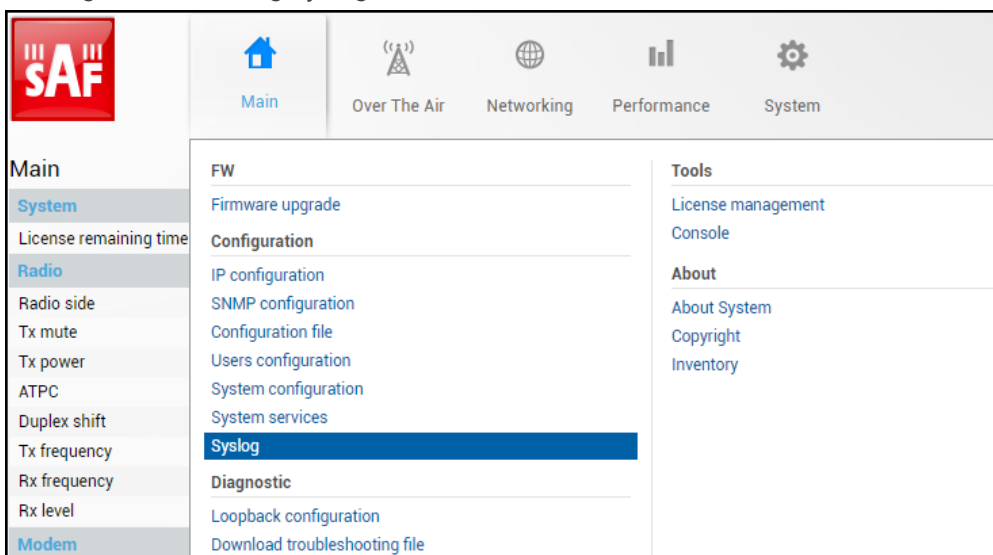

Status mode

System / Syslog		
Syslog service	1	Disabled
Facility code	2	17 (local1)
Server severity	3	7 (debug)
Syslog label	4	LOW Integra-GS
Syslog server IP	5	192.168.1.31
Syslog server port	6	514

Press  **MODIFY** button.

Modify mode

System / Syslog		
Syslog service	1	<input type="checkbox"/> Enable
Facility code	2	17 (local1) ▼
Server severity	3	7 (debug) ▼
Syslog label	4	LOW Integra-GS
Syslog server IP	5	192.168.1.31
Syslog server port	6	514
		7 Execute configuration

- 1) **Syslog service** – allows enabling or disabling Syslog service on the device.
- 2) **Facility code** – allows selecting facility code for the Syslog messages from the device. Messages with different facility codes may be handled differently on the Syslog server. The following facility codes are possible:
 - 16 (local0);
 - 17 (local1);
 - 18 (local2);
 - 19 (local3);
 - 20 (local4);
 - 21 (local5);
 - 22 (local6);
 - 23 (local7).
- 3) **Server severity** – allows selecting maximal severity (priority) level for sensor log event messages that will be sent from the device to the Syslog server. Each sensor has 4 log event types that trigger Syslog message sending:
 - **set** – indicates the time when the current sensor value comes out of the normal value range or the current sensor value is not valid at all;
 - **reset** – indicates the time when the current sensor value comes back to normal value range from the previous set event state;
 - **down** – indicates the time when the sensor stops receiving data about the parameter it monitors, for example, due to some hardware fault;
 - **up** – indicates the time when the sensor recovers data reception about the parameter it monitors from the previous down event state.

Additionally, each event type can have one of 8 severity levels:

- 0 (emerg);
- 1 (alert);
- 2 (crit);
- 3 (error);
- 4 (warn);

- 5 (notice);
- 6 (info);
- 7 (debug).

By default, all sensors have the following severity levels for each of their 4 event types:

- set alert;
- reset notice;
- down alert;
- up notice.

Log event severity can be changed with the CLI command ***log sensor mgmt <sensor> message <event> <severity>***.

- 4) ***Syslog label*** – allows selecting additionally textual labeling/tagging for Syslog messages.
- 5) ***Syslog server IP*** – allows configuring an IP address for the Syslog server where the device should send Syslog messages.
- 6) ***Syslog server port*** – allows configuring port that the device should use for Syslog message sending.
- 7) By pressing „*Execute configuration*“, changes made to the corresponding section apply only to the local side Integra-W/Integra-WS.

CLI commands (Chapter 4: COMMAND LINE INTERFACE)

log syslog cfg	Use to show current Syslog configuration
log syslog disable	Use to disable Syslog message sending
log syslog enable	Use to enable Syslog message sending
log syslog facility <facility code>	Use to set facility code for Syslog messages
log syslog ip <IP address>	Use to set an IP address for the Syslog server
log syslog label <syslog_label>	Use to set label/tag for Syslog messages
log syslog port <syslog_port>	Use to set a port for the Syslog server
log syslog severity <severity>	Use to set the maximal severity level for Syslog messages that will be sent from the device
log group mgmt <name> add destination {event perf snmp syslog}	Use to add a destination for a group.
log group mgmt <name> remove destination {event perf snmp syslog}	Use to remove a destination from a group.
log sensor mgmt <sensor> message <event> <severity>	Use to set the severity level for sensor event log messages

System → Diagnostic → Loopback configuration

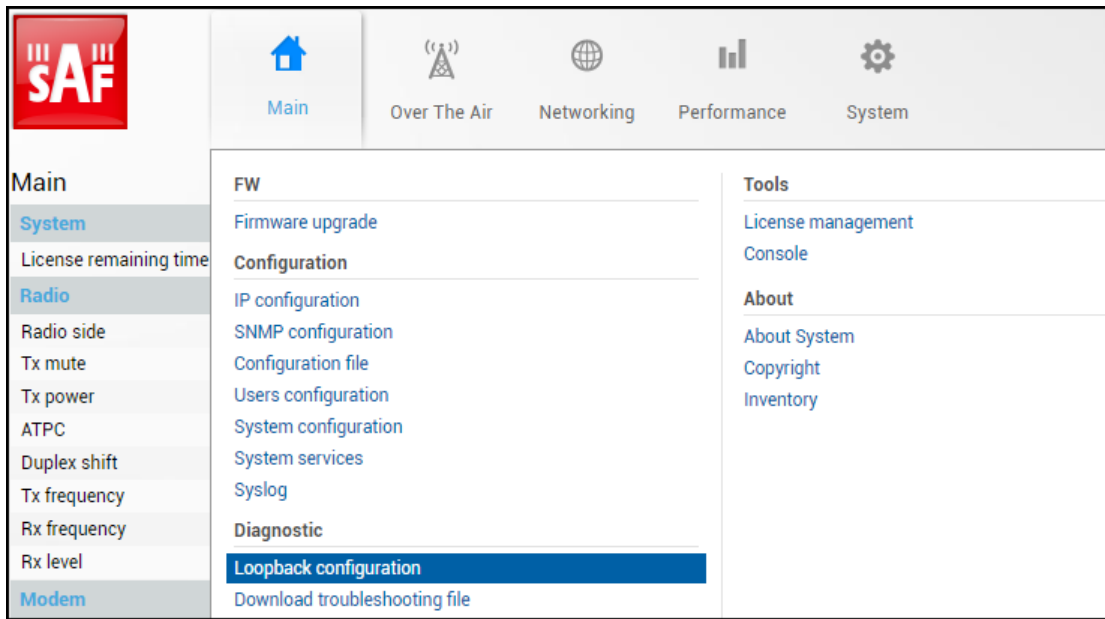

Status mode



Press MODIFY button.

Modify mode

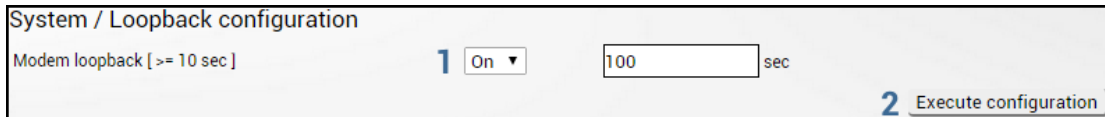

- 1) **Modem loopback** – Indicates whether modem loopback is active (status mode); Allows enabling modem loopback by changing status to “On” and specifying loopback duration time (modify mode). During modem loopback, the signal is looped back to local end after the modem and Integra-W/Integra-WS should be able to synchronize to itself. Both Signal Quality and FEC load should not generate an alarm (values should not be colored in red). When loopback is activated, “Loopback duration time” countdown timer will appear.
- 2) By pressing „Execute configuration” changes made to the corresponding section apply only to the local side Integra-W/Integra-WS.



While modem loopback is active “Modem loopback: Enabled, digital” indication will be shown on the Main status page.

Below is an example of the Main status page during modem loopback:

Main		
System	Local	Remote
License remaining time	20 days 22:41:24	N/D
Radio	Local	Remote
Radio side	High	N/D
Tx mute	Disabled	N/D
Tx power	17 dBm	N/D
ATPC	Disabled	N/D
Duplex shift	1560 MHz	N/D
Tx frequency	19600 MHz	N/D
Rx frequency	18040 MHz	N/D
Rx level	-54 dBm	N/D
Modem	Local	Remote
Bandwidth	80 MHz FCC	N/D
Modem profile	1024QAM ACM	N/D
Modem loopback	Enabled, digital	N/D
ACM engine	Enabled	N/D
Acquire status	Locked	N/D
Signal quality	100 %	N/D
FEC load	0 %	N/D
Current Rx modulation	1024QAM	N/D
Current Tx modulation	1024QAM	N/D
Current Rx Ethernet capacity	643.1 Mbps	N/D
Current Tx Ethernet capacity	643.1 Mbps	N/D
Ethernet		
Port	LAN (Electrical)	MNG (Electrical)
State	Enabled	Enabled
Status	Down	Up

CLI commands (Chapter 4: COMMAND LINE INTERFACE)

modem loopback	Use to show modem loopback status.
modem loopback digital <10..1000000>	Use to enable modem loopback for a specified time in seconds.
modem loopback none	Use to disable modem loopback.

System → Diagnostic → Download troubleshooting file

By navigating to the “Download troubleshooting file” a “.tar.gz” archive containing various troubleshooting data files will be automatically generated and downloaded to your PC.



When contacting SAF technical support team (techsupport@saftehnika.com) regarding troubleshooting issues, please provide the troubleshooting file.

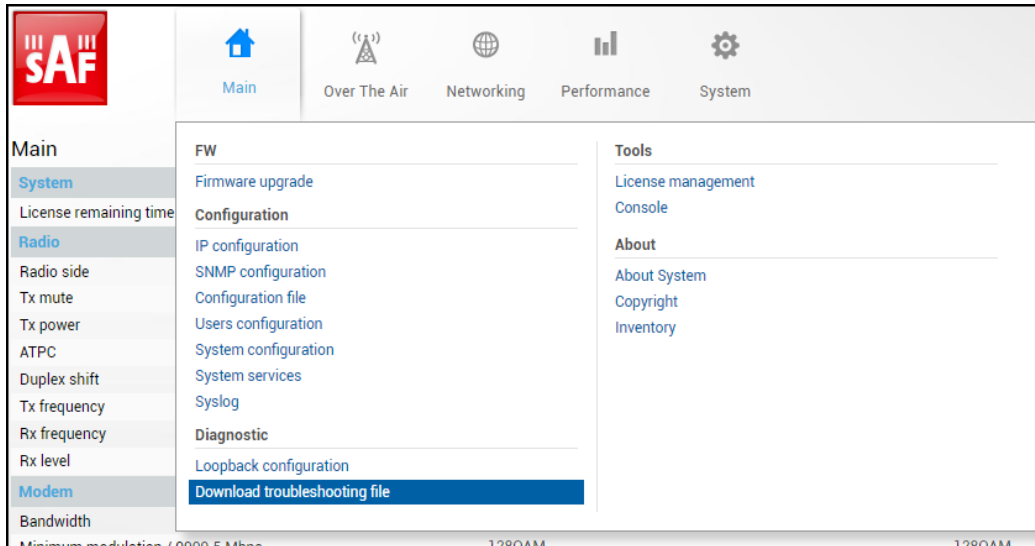

Clicking on the link will download troubleshooting file archive package to your hard disk drive (“Downloads” folder of your browser).

File contents:

conf	Subfolder with last configuration files.
config.txt	Saved system configuration file.
constell.bmp	Snapshot of modem constellation graph.
devel.tar.gz	For debugging only.
eventlog.txt	Alarm-event log file.
Perflog_347040100173_D15WSR01_L_2023-12-22_14-36-47.zip	Archive containing performance log files with maximum 1440 entries for 1, 15, and 60-minute intervals.
spectrum.bmp	Snapshot of modem Rx spectrum graph.
troubleshoot.html	Information on currently running firmware and stored firmware files; system configuration including Web services, RADIUS, IP address, user, NTP configuration, and inventory info; SNMP v1/v2c/v3 configuration; alarm status, alarm threshold, and sensor configurations; radio status, configuration, and counters; currently active license and added license files; modem including modem status and configuration, counters, list of allowed modem profiles, header compression; Ethernet configuration and counters of LAN, WAN and MNG ports.

System → Tools → License management

Provides a list of available licenses, time left for each license and license upload controls.

Status mode

System / License management

Available licenses 1

License	License remaining time	Version
K7PXACXN.lic	30 days 00:51:00	2
LHU2S5VG.lic	Unlimited	2
Q4GXA2JC.lic	Unlimited	2

Selected license 6

License	K7PXACXN.lic	
Version	2	
Time	30 days 01:00:00	
License remaining time	30 days 00:51:00	

Modem

Capacity limit	120 Mbps		
Bandwidth	Modulation points		Features
	Min	Max	
Unlimited	4	1024	

Ethernet

Rate limit	Unlimited
------------	-----------

Press **MODIFY** button.

Modify mode

System / License management

Available licenses		
License	License remaining time	Version
K7PXACXN.lic	30 days 00:48:07	2
LHU2S5VG.lic	Unlimited	2
Q4GXA2JC.lic	Unlimited	2

Buttons: **2** Select active license, **3** Activate

File selection: **4** Choose File (No file chosen), **5** Upload

Selected license	
License	Q4GXA2JC.lic
Version	2
Time	Unlimited
License remaining time	Unlimited

Modem		
Capacity limit	1000 Mbps	
Bandwidth	Modulation points	Features
	Min	Max
Unlimited	4	1024

Ethernet	
Rate limit	Unlimited

- 1) Shows list of available licenses and remaining time. The active license is in bold.
- 2) **Select active license** – Press to highlight in the list the active license.
- 3) **Activate** – Select license from the list and press “Activate” to switch to preferable license.
- 4) **Choose file** – Press to browse for a license file (*.lic) on your hard disk drive.
- 5) **Upload** – Press to upload a license file (*.lic) to Integra-W/Integra-WS.
- 6) Details of the selected license.

If new license supports previously running modem configuration, no changes will be applied. If previously modem was configured to modem configuration, which is not supported by new license key, the modem will be reconfigured to the maximally allowed configuration in chosen channel bandwidth.



When the license expires, modulation will drop to “4QAM Limited” and link capacity will drop to 256Kbps.



When the license expires, next license in the list needs to be activated manually.

CLI commands (Chapter 4: COMMAND LINE INTERFACE)

license list	Use to list available licenses.
license list active	Use to view settings of currently active license.
license file restriction <filename>	Use to view settings of a license file.
license file list	Use to list available license files.
license file add <filename>	Use to add uploaded license file to license file list from the FTP directory.
license file activate <filename>	Use to activate previously added license file.

System → Tools → License management, steps on adding and activating a new license

For activating a license, please follow these steps:

- 1) Open License management page in Web GUI [System → Tools → License management](#).
- 2) Press „MODIFY” button.
- 3) Press “Choose File” or “Browse” (depending on the browser used), navigate to the license file (*.lic), select it and press “Upload”.
- 4) Choose uploaded license from the list and press “Activate” button.

If a new license supports the current modem configuration, no changes will be applied.

If the modem was configured to a modem configuration which is not supported by the new license key, the modem will be reconfigured to the maximum allowed configuration in the chosen channel bandwidth.

System → Tools → Console

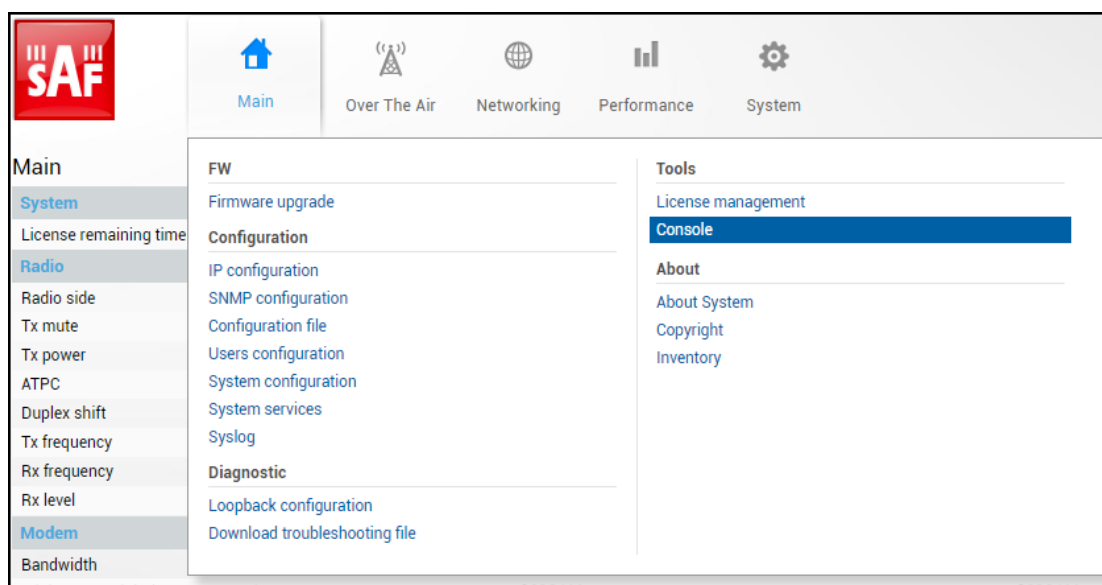

```
System / Console
SAF>
configuration      - User configuration commands
firmware           - Firmware update and information
help               - CLI usage
license            - License commands
log                - Event / Performance log control and configuration
modem              - Modem commands
network            - Network functionality
product            - Product toolbox
radio              - Radio commands
snmp               - SNMP configuration commands
system             - System configuration
```

Use syntax "<command> ?" to see information on subcommands.

Use ↵ ENTER key to execute entered command.

List of valid CLI commands can be found at the end of each Web GUI page description.

Refer to [Chapter 4: COMMAND LINE INTERFACE](#) for details how to connect to other CLI interfaces (serial, SSH, Telnet).

System → About → About System

Provides a short description of Integra-W/Integra-WS series products.

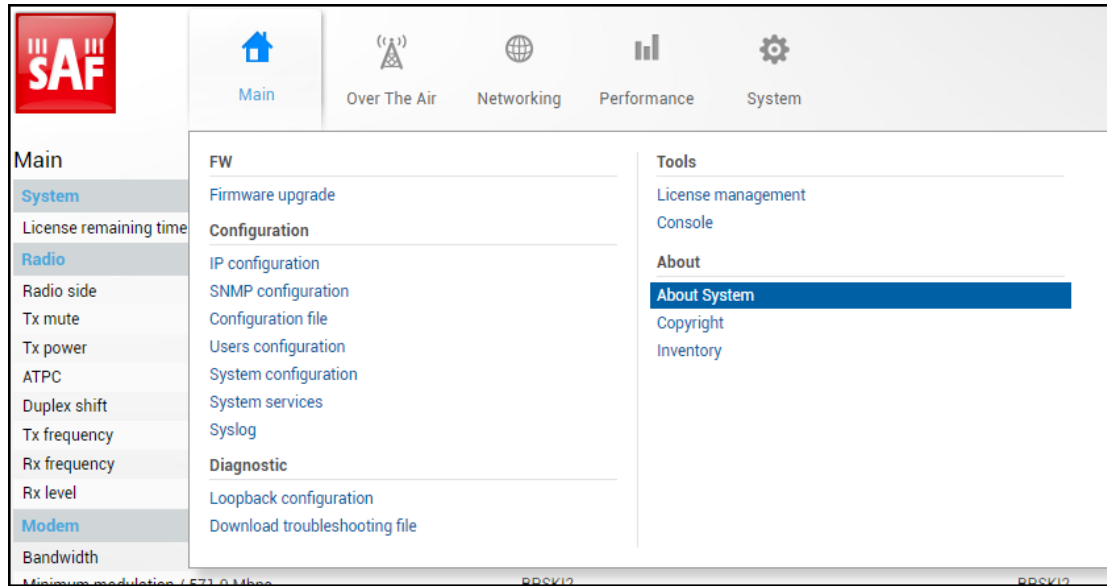

System / About System

Next generation all-outdoor microwave radio product

Integra is an unbelievably light, energy efficient carrier-grade system that exemplifies an outstanding return on smart engineering - the synergy of high competence in radio electronics and materials science. Integration of next generation microwave radio with high performance antennas into a single unit translates into a lower total cost of ownership, as well as less time spent on the installation site, and better reliability of the link even in densely served areas.

CLI commands (Chapter 4: COMMAND LINE INTERFACE)

product info	Use to show detailed information on Integra-W / Integra-WS FODU.
system number	Use to show Integra-W / Integra-WS serial number.

System → About → Copyright

Displays copyright information.

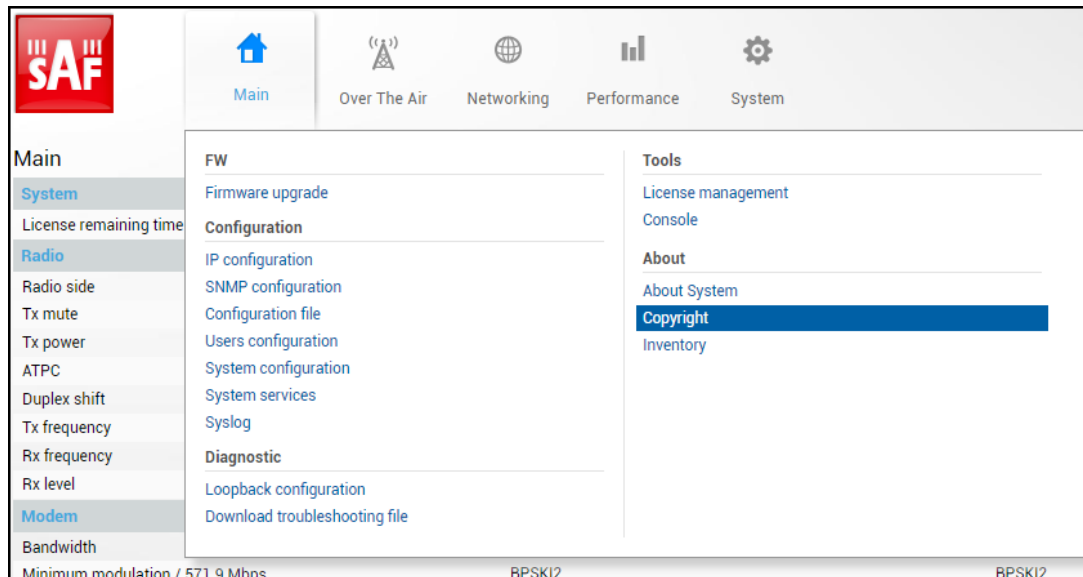

System / Copyright

Copyright (c) 2013 SAF Tehnika JSC. All rights reserved.

All content included on this site, such as text, graphics, logos, button icons, images, as well as any compilation in form of collection, arrangement, and assembly is the exclusive property of SAF Tehnika JSC and protected by Latvia and international copyright laws. All software used on this site is the property of SAF Tehnika JSC or its partners and protected by Latvia and international copyright laws. The content and software on this site may be used as a management tool for Integra microwave radio equipment. Any other use, including the reproduction, modification, distribution, transmission, republication, display or performance, of the content on this site is strictly prohibited.

THE INTEGRA MICROWAVE SOFTWARE AND HARDWARE IS PROVIDED BY SAF TEHNIKA JSC "AS IS" AND ANY EXPRESS OR IMPLIED WARRANTIES, INCLUDING, BUT NOT LIMITED TO, THE IMPLIED WARRANTIES OF MERCHANTABILITY AND FITNESS FOR A PARTICULAR PURPOSE ARE DISCLAIMED. IN NO EVENT SHALL THE SAF TEHNIKA JSC BE LIABLE FOR ANY DIRECT, INDIRECT, INCIDENTAL, SPECIAL, EXEMPLARY, OR CONSEQUENTIAL DAMAGES (INCLUDING, BUT NOT LIMITED TO, PROCUREMENT OF SUBSTITUTE GOODS OR SERVICES; LOSS OF USE, DATA, OR PROFITS; OR BUSINESS INTERRUPTION) HOWEVER CAUSED AND ON ANY THEORY OF LIABILITY, WHETHER IN CONTRACT, STRICT LIABILITY, OR TORT (INCLUDING NEGLIGENCE OR OTHERWISE) ARISING IN ANY WAY OUT OF THE USE OF THIS SOFTWARE AND HARDWARE, EVEN IF ADVISED OF THE POSSIBILITY OF SUCH DAMAGE.

System → About → Inventory

Displays inventory information.

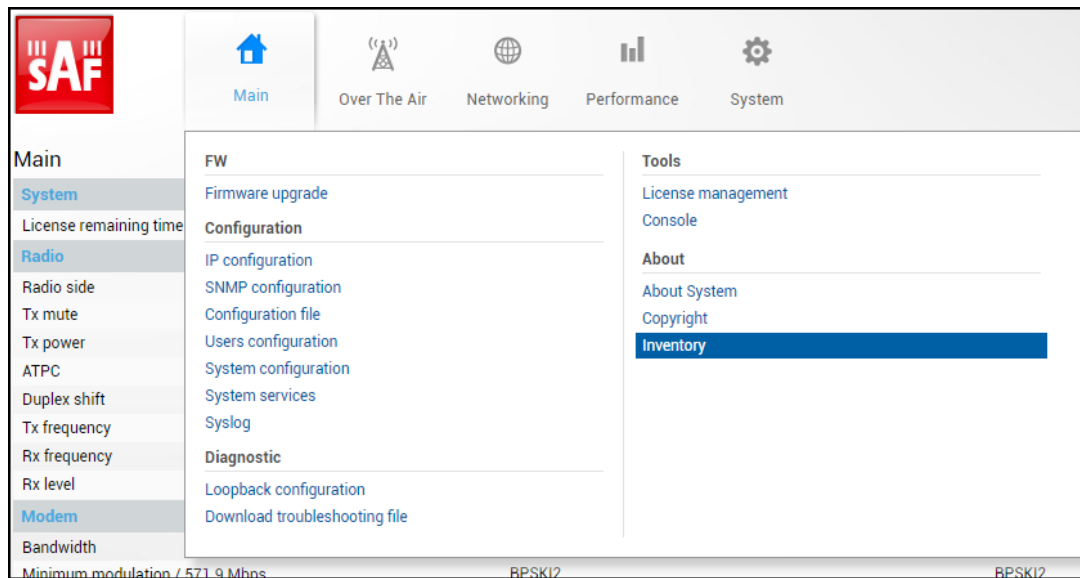

System / Inventory

MB ID	1
MB Sub ID	0
MB revision	3
MAC	000.004.166.129.067.166 - 00.04.A6.81.43.A6
Model	Integra-WS
System Contact	techsupport@saftehnika.com
Device Name	SAF
Description	SAF microwave radio
Copyright	Copyright (c) 2013 SAF Tehnika JSC. All rights reserved.
Product Code	D23WSR01L
Product Serial Number	398780100009
Enterprise ID	7571

Chapter 4: COMMAND LINE INTERFACE

Command line interface (CLI) is available via 4 individual interfaces:

- Secure Shell (SSH);
- Telnet;
- Serial terminal;
- Web GUI (System → Tools → Console, partial functionality).

The available CLI commands are found in “CLI commands” tables in appropriate Web GUI page sections in [Chapter 3: WEB GUI](#).

For SSH, Telnet or serial connection you can use any client supporting corresponding interfaces (e.g., PuTTY, Tera Term etc.).



CLI commands are not case sensitive.

A User can abbreviate commands and parameters as long as they contain enough letters to be distinguished from any other currently available commands or parameters.

Useful CLI keyboard shortcuts can be printed by CLI command **help**.

```
SAF>help
Enter          - Execute current line
Tab            - Complete current line
Home           - Move cursor to beginning
End            - Move cursor to the end
Up/Down        - History navigation
Ctrl-k         - Delete the rest of the line
Ctrl-w         - Delete a word
Ctrl-c         - End session
marked text    - Indication of erroneous user input
```

Note that in Web GUI (System → Tools → Console) those shortcuts will not work.

Connecting to serial RS232 interface

In order to connect to Integra-W/Integra-WS serial terminal, you will require USB cable with USB Type B connector. Please refer to [Chapter USB port](#) for pinouts.

To connect the PC to the RS232 management port, using serial terminal-emulation software (e.g. [PuTTY](#)), use the following parameters:

- Baud rate: 115200
- Data bits: 8
- Parity: None
- Stop bits: 1
- Data flow control: None

Below are connection steps with [PuTTY](#) - Windows freeware software.

- 1) Open [PuTTY](#) and go to “Serial” category. Specify your COM port number you will be using, change “Speed (baud)” to “115200” and “Flow control” to “None”:

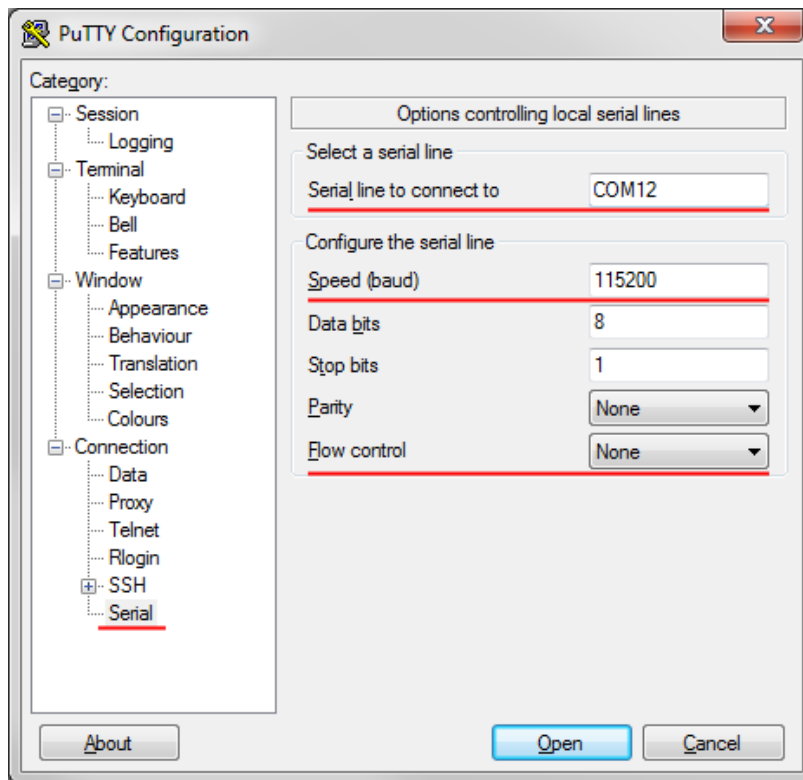

- 2) Press “Open” and after pressing “Enter” key following login dialog should appear:

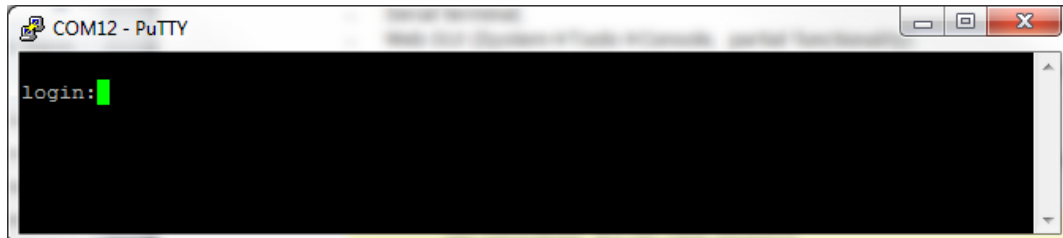

- 3) Enter username and password. Default credentials are as follows:
 - login: **admin**
 - password: **changeme**
- 4) After successful login “SAF>” prompt should appear (prompt will differ if system name is not the default one):

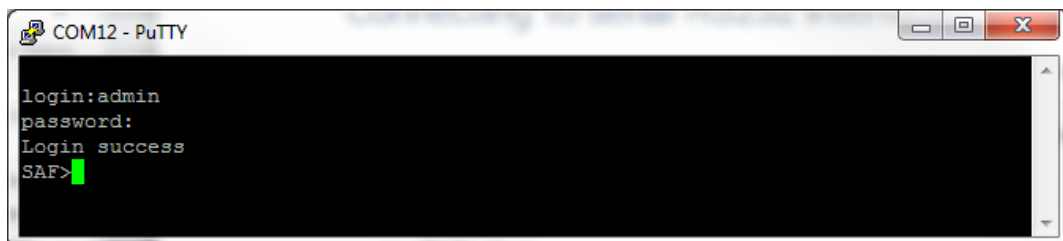

- 5) Press “Ctrl+C” to log off from the current session.

 Closing [PuTTY](#) window without “Ctrl+C” does not log off from the current serial terminal session.

Connecting to SSH

SSH connection to Integra-W/Integra-WS FODU is carried out using Ethernet management connection. Please refer to Chapter [Ethernet management connection](#) for Ethernet management port connection details.

You can use any SSH client. Below are connection steps with [PuTTY](#) - Windows freeware software.

- 1) Open *PuTTY*, choose "Connection Type": "SSH", enter IP address and make sure that correct port number is used ("22" by default):

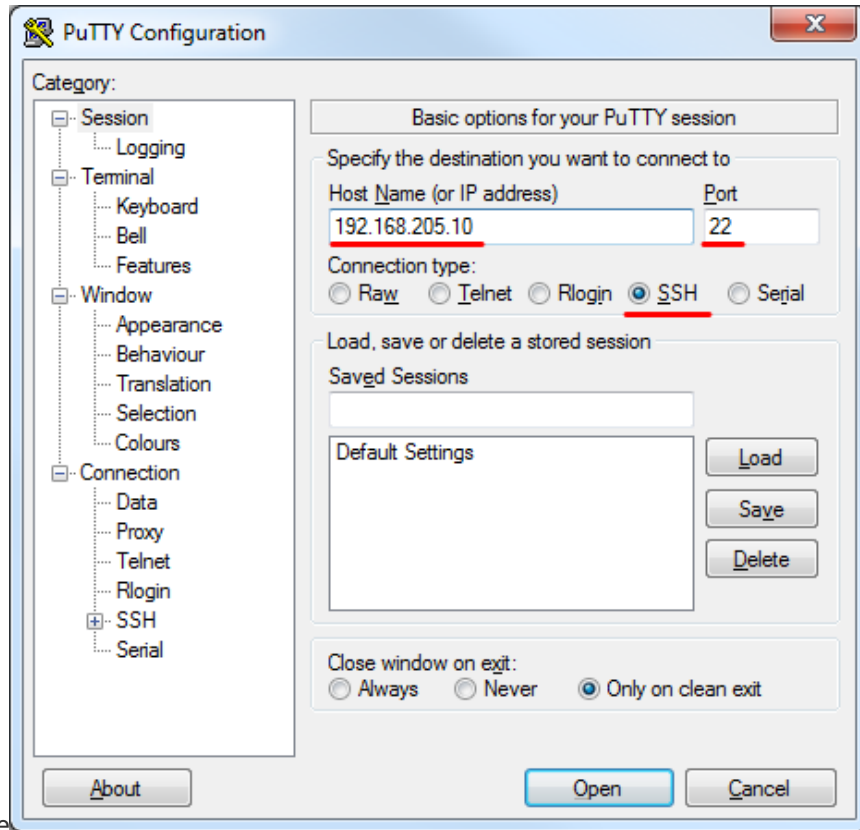

- 2) Press "Open", enter login credentials (default user name is *admin* and password - *changeme*). After successful login following prompt should appear:

```
login: █
```

- 3) Enter username and password. Default credentials are as follows:
 - login: **admin**
 - password: **changeme**
- 4) After successful login "SAF>" prompt should appear (prompt will differ if system name is not the default one):

```
login: admin
password:
Login success
SAF> █
```

Connecting to Telnet

A telnet connection to Integra-W/Integra-WS FODU is carried out using Ethernet management connection. Please refer to Chapter [Ethernet management connection](#) for Ethernet management port connection details.

By default, Telnet service is disabled. See Chapter [System → Configuration → System services](#) for how to manage system services.

You can use any Telnet client. Below are connection steps with [PuTTY](#) - Windows freeware software.

- 1) Open *PuTTY*, choose “Connection Type”: “Telnet”, enter IP address and make sure that correct port number is used (“23” by default):

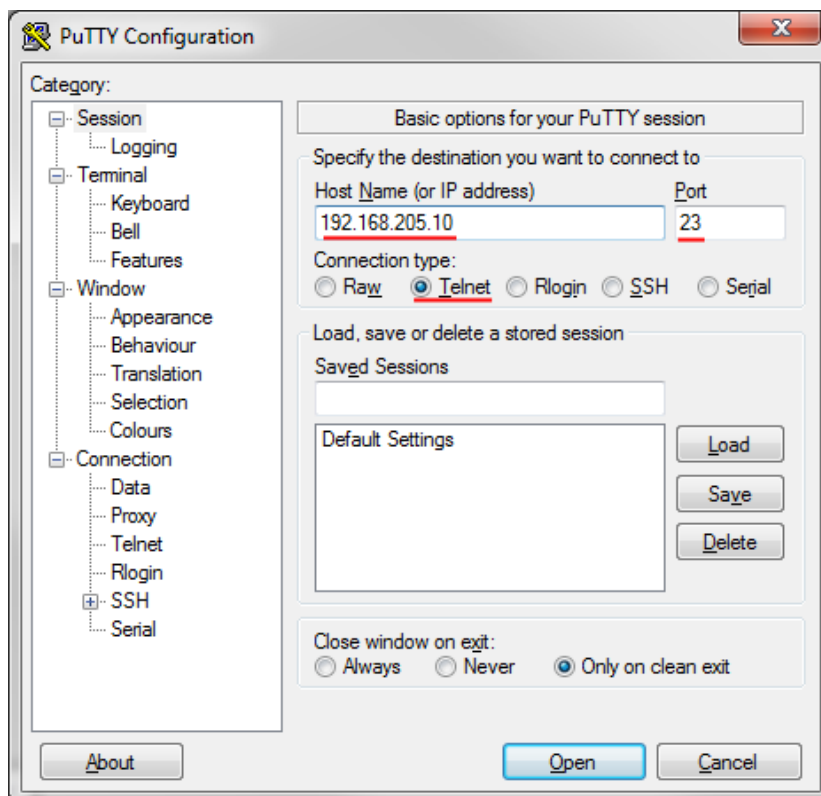

- 2) Press “Open” to connect. After successful connection following prompt should appear:

```
login: █
```

- 3) Enter username and password. Default credentials are as follows:
 - login: **admin**
 - password: **changeme**
- 4) After successful login “SAF>” prompt should appear (prompt will differ if system name is not the default one):

```
login: admin
password:
Login success
SAF> █
```

Chapter 5: 17/24GHz

Polarization Considerations

Polarizations at both ends of the link must be opposite for 17/24 GHz Integra-W/Integra-WS FODUs.

For example:

If High side radio is installed in Vertical polarization, then Low side radio must be installed in Horizontal polarization:



Radio configuration – extra fields

This chapter describes **only differences** of the configuration for the 17/24 GHz Integra-W/Integra-WS FODUs. For configuration in general, refer to the chapter [Over The Air → Radio → Configuration](#).

Status mode

Over The Air / Radio configuration		
Tx power (-26 .. -16 dBm for 4QAM)		-16 dBm
Duplex shift (140.00 .. 140.00 MHz)	1	140 MHz
Tx frequency (24220.00 .. 24220.00 MHz)		24220 MHz
Antenna (cm)	2	30
Country	3	LV

Press MODIFY button.

Modify mode

Over The Air / Radio configuration		
Tx power (-26 .. -16 dBm for 4QAM)		<input type="text" value="-16"/> dBm
Duplex shift (80.00 .. 140.00 MHz)	1	<input type="text" value="140.00"/> MHz
Tx frequency (24191.75 .. 24248.25 MHz)		<input type="text" value="24220.00"/> MHz
Antenna (cm)	2	<input type="text" value="30"/>
Country	3	<input type="text" value="LV"/>

- 1) **Duplex shift** – Indicates the value between the transmitter frequency and receiver frequency (status mode); allows specifying the value of duplex shift in MHz (modify mode).
- 2) **Antenna** – Indicates the set size of the installed antenna (status mode); allows specifying the diameter of the installed antenna in cm (modify mode). Max Tx power

settings depend on national regulatory EIRP allowance and antenna size. Available values - 20, 30, 60, 99, 120 cm.

- 3) **Country** – Indicates the set country code (status mode); allows specifying the country code (modify mode). Max Tx power settings depend on national regulatory EIRP allowance and antenna size. Available values - AU, AT, BE, BG, CA, CY, CZ, DK, EE, FI, FR, DE, GR, HU, IE, IR, IT, LV, LT, LU, MT, NL, PL, PT, RO, SK, SI, ES, SE, UK, US, Custom.

CLI commands (Chapter 4: COMMAND LINE INTERFACE)

radio duplex-shift [<value>]	Use to show/define the value of duplex shift in kHz.
radio eirp set <antenna> <country>	Use to define antenna size in cm and country code.
radio [status]	Use to show radio status and the existing values.

Setting bandwidth to 80MHz

This chapter describes only differences of setting 80 MHz bandwidth for the 17/24 GHz Integra-W/-WS FODUs. For configuration in general, refer to the chapter [Over The Air → Radio → Configuration](#).

Unavailable channel bandwidths (100 and 112MHz) will not be selectable due to “Disabled by duplex shift”, maximum allowed channel bandwidth for Integra-W/-WS 17/24GHz radio units – 80MHz.

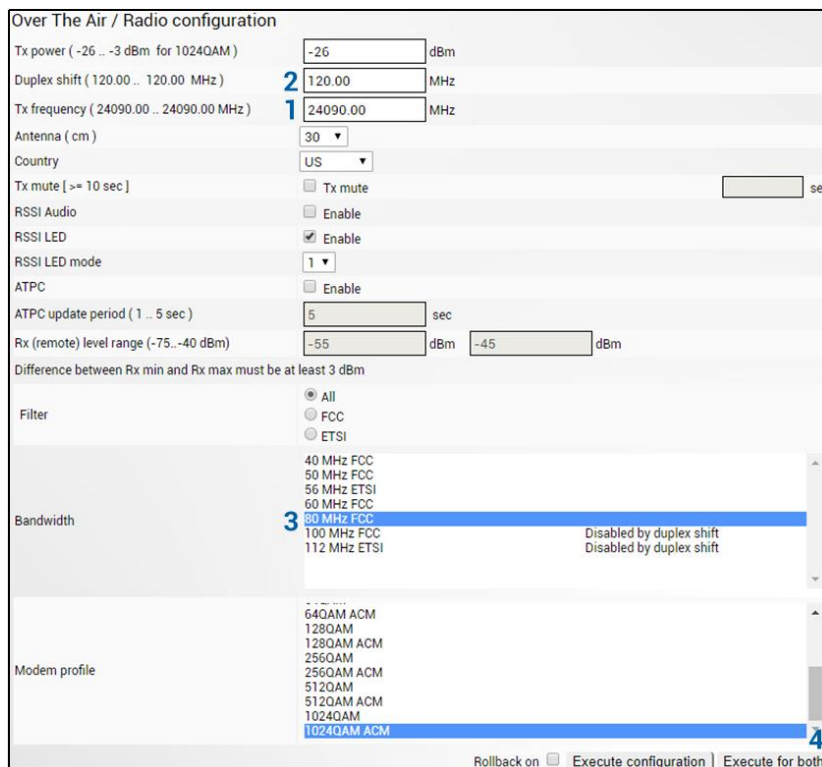

- 1) Access the Web GUI. Configure the Tx frequency to 17140MHz (17GHz) or 24090MHz (24GHz) if it is low side unit or to 17260MHz (17GHz) or 24210MHz (24GHz) if it is high side unit.
- 2) Configure the Duplex shift to 120 MHz.
- 3) Configure Bandwidth profile by selecting 80 MHz profile.
- 4) Configure Modem profile and press “Execute for both”.
- 5) Save the configuration on both radios.

Chapter 6: FUNCTIONAL DESCRIPTION

Information about built-in cooling fans

Integra-W/Integra-WS 6-13GHz FODU have two class IP68 built-in cooling fans. The operation and monitoring of the cooling fans are automatically managed by the device software and users cannot control or intervene with their operation, for example, turn on or turn off any of them.

The cooling fans are turned on in the following situations:

1. When the device is powered up (cooling fan operation time 2 minutes);
2. After the reboot of the device (cooling fan operation time 2 minutes);
3. Once after every 24 hours of operation (self-check mode, operation time 2 minutes);



The cooling fans in all 3 above-mentioned situations will be turned on only if the temperature on the casing of the device will be 20°C and higher.

4. When the temperature on the casing of the device reaches over 60°C. The fan operates until the temperature decreases to 55°C.

CLI commands (Chapter 4: COMMAND LINE INTERFACE)

system fan events <enable disable>	Use to enable or disable fan status indication in the event log
system fan	Use to view fan status condition

The following fan status conditions are possible:

ON – indicates that the cooling fans are turned on;

OFF – indicates that the cooling fans are turned off.

FROZEN START – indicates that the temperature measured on the casing of the device is below 20°C and cooling fans will not be turned on upon device reboot, power-on, or 24-hour self-check. Fans will turn on only when the temperature goes above 20°C.

The system fan command output will show the following information:

```

system fan
SAF>          FAN STATUS:
              State #1      OFF      1
              State #2      OFF      2
              System temperature 58      3
              Rotation per minute #1 OFF      4
              Rotation per minute #2 OFF      5
              State event output DISABLED 6

RUNNING CONFIGURATION:
fan_available Yes      7
time_on      120      8
time_off     86400    9
timehyst     20      10
temp_max     60      11
temp_delta   5       12
temp_freeze  20      13
speed_min    1000    14
speed_max    10000   15
speed_delta  150     16
state_msg    0       17

```

- 1) **State #1** – shows the operational status of 1st fan in the device.
- 2) **State #2** – shows the operational status of 2nd fan in the device.
- 3) **System temperature** – shows the last recorded temperature measurement in Celsius degrees from the casing of the device.
- 4) **Rotation per minute #1** – shows the rotation speed of the 1st fan in the device.
- 5) **Rotation per minute #2** – shows the rotation speed of the 2nd fan in the device.

- 6) **State event output** – shows whether fan status indication is recorded in the event log of the device.
- 7) **fan_available** – shows whether the device can detect installed fans.
- 8) **time_on** – shows the time in seconds for how long fans will turn on in case of the device reboot, power-on, or 24-hour self-check.
- 9) **time_off** – shows the time in seconds for periodic fan self-checks. 86400 seconds = 24 hours.
- 10) **timehyst** – shows the delay time in seconds for when the device will stop temperature measurements and wait idly after any fan status change.
- 11) **temp_max** – shows the temperature threshold in Celsius degrees which reached will initiate the fan turning on.
- 12) **temp_delta** – shows the temperature difference from temp_max to which temperature on the casing of the device should decrease for fans to turn off.
- 13) **temp_freeze** – shows the temperature threshold in Celsius degrees below which fans will not be switched on in case of the device reboot, power-on, or 24-hour fan self-check.
- 14) **speed_min** – shows minimally acceptable fan rotation speed (rounds per minute) in ON status. If fan rotation speed falls below this value in ON status, then the device will detect that fan is rotating too slow and will generate an alarm.
- 15) **speed_max** – shows maximal acceptable fan rotation speed (rounds per minute) in ON status. If the fan rotation speed exceeds this value in ON status, then the device will detect that fan is rotating too fast and will generate an alarm.
- 16) **speed_delta** – shows the rotation speed (rounds per minute) difference by which the fan speed should change to return to normal operation mode and fan alarm to clear after it has reached speed_max or speed_min threshold. speed_max alarm will clear when rotation speed has decreased by speed_delta, speed_min – when the speed has increased by speed_delta;
- 17) **state_msg** - shows whether fan status indication is recorded in the event log of the device.

During self-check and cooling conditions or in case of system or cooling fan failure, the following events/alarms will be registered in the active alarm status and the event log ([Performance](#) → [Alarm](#) → [Alarm status](#) and [Performance](#) → [Alarm](#) → [Alarm event log](#)):

The fan #<No.> speed FAILURE ON - tested speed <current_speed> rpm (MIN <conf_min>, MAX <conf_max>) – SET	This alarm will be set if the measured speed (Revolutions per Minute) of the cooling fan is outside the predefined range
The fan #<No.> speed <current_speed> rpm – RESET	In case if measured speed returns within the predefined speed range, the alarm will be reset
Fan: communication error (<Error CD>)	Indication in case the system cannot read the data from cooling fans
Fan: error msg received : <Error Msg>	Indication in case the system cannot read the data from the cooling fans, or the data received from cooling fans is errored

If SNMP trap sending is configured on the device, they will be also sent for fan alarms.

ACM (Adaptive Coding and Modulation)

ACM technology allows operators to achieve high-capacity data transmission over microwave links and improve the link utilization. This reduces both operational and capital expenditures for maintaining high-capacity links. ACM can maintain the highest link spectral efficiency possible at any given time in any link condition.

In traditional voice-dominated wireless backhaul transmission networks, service availability levels of 99.995% are the norm.

However, newer services such as Internet browsing, video streaming and video conferencing can operate at more relaxed availability levels. With the use of QoS prioritizing ACM can allocate

the required availability based on the priority. As a result, high-priority services such as voice enjoy 99.995% availability, while low-priority services like video streaming are allocated lower priorities.

Use of QoS prioritizing defines which services should be transmitted under any link condition and which services should be adapted whenever the link condition is degraded, and the link payload is decreased.

For example, when bad weather has decreased the channel capacity of a link, ACM maintains high-priority services – such as voice data – with full bandwidth capacity while adapting the bandwidth capacity of low- and mid-priority services such as Internet browsing.

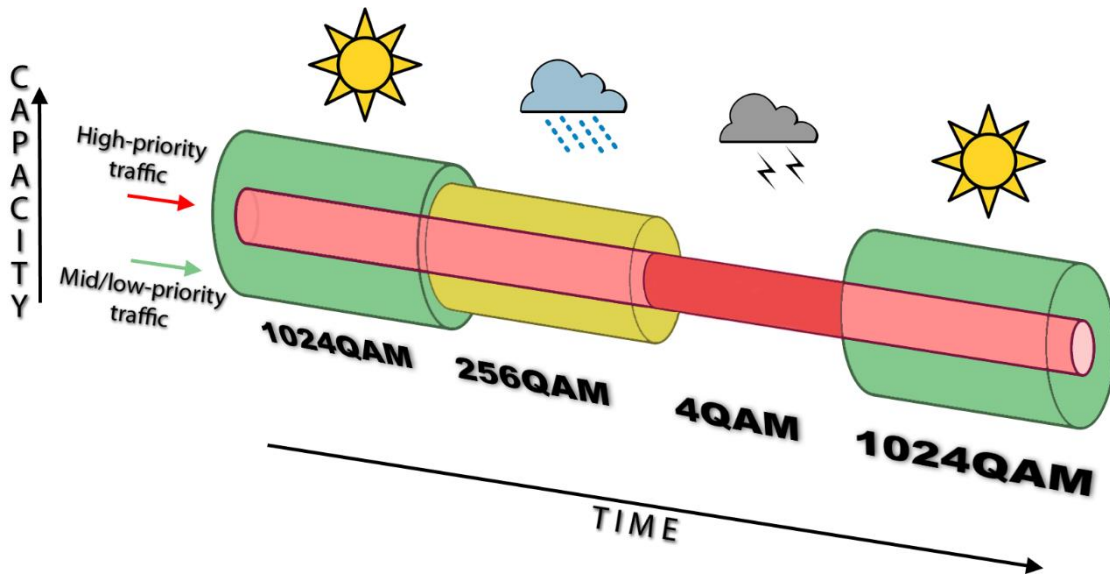

Traffic can be mapped into different priorities, which define the level of service for each application. The figure below illustrates how different services – such as rich voice and video – are mapped into different classes of availability (CoA) such as 99.995% or 99.687%.

The implementation of multiple priorities increases the available capacity up to 10 times that of standard links. When conditions are clear, the wireless link operates at maximum capacity and provides all services with the full data rate. When link conditions are poor – during harsh rain, for example – predefined high-availability services such as voice are not affected. However, the capacity of low-priority services is adapted dynamically to the changing link conditions. This is done by provisioning bandwidth according to the link conditions and traffic priority.

An ACM profile defines the link parameters (modulation) for a given range of the *signal quality* value, which is an estimation of SNR expressed as a percentage. The *signal quality* range of each profile defines the threshold for switching from one ACM profile to another. Each ACM profile has a different spectral efficiency, derived from its modulation.

In order to maintain linearity, Tx power decreases for higher modulations. Tx power difference between 4QAM and 1024QAM is 5dB.

The receiver continuously monitors the link condition based on *signal quality* value.

Once the *signal quality* value exceeds the threshold of the current ACM profile, an ACM switching process will be initiated. In case of degradation in the link performance, the new ACM profile will include lower modulation, decreasing the link bitrate. The ACM switching rate is hitless, meaning that no data will be lost during a change of ACM profiles.

Signal quality values for ACM downshift and upshift can be found in the table below:

	40 MHz	50 MHz	56 MHz	60 MHz	80 MHz	100 MHz	112 MHz
8QAM-->4QAM	74.6	74.6	74.6	74.6	74.6	70.7	70.7
4QAM-->8QAM	95.7	95.7	95.7	95.7	95.3	95.3	95.3
16QAM-->8QAM	68.8	68.8	73.0	69.5	68.0	69.9	68.0
8QAM-->16QAM	91.8	91.0	91.4	91.4	91.4	91.8	90.2
32QAM-->16QAM	68.4	68.4	68.4	68.4	69.1	69.5	69.5
16QAM-->32QAM	91.4	91.4	91.4	91.4	91.4	91.4	91.4
64QAM-->32QAM	67.2	67.2	69.5	68.0	64.8	64.8	64.8
32QAM-->64QAM	92.2	92.2	92.2	92.2	91.0	91.8	91.0
128QAM-->64QAM	64.5	65.2	66.8	66.8	62.9	64.1	62.9
64QAM-->128QAM	89.8	89.8	90.2	90.2	89.1	89.1	89.1
256QAM-->128QAM	64.8	63.3	65.2	65.2	59.8	60.5	59.8
128QAM-->256QAM	91.4	90.6	90.2	90.2	89.1	88.7	87.9
512QAM-->256QAM	62.9	62.1	62.5	59.0	58.2	57.8	56.3
256QAM-->512QAM	88.7	88.7	87.9	86.7	86.7	86.3	84.8
1024QAM-->512QAM	60.2	60.9	59.4	56.3	52.0	50.0	47.3
512QAM-->1024QAM	88.7	89.1	87.1	85.9	84.0	82.4	81.3

For example, the link is configured to 1024QAM modulation in 112MHz bandwidth. In order to operate with the highest modulation (and maximum capacity), *signal quality* should be >47.3%. If *signal quality* exceeds this threshold, ACM will downshift to 512QAM. Degrading below 56.3% at 512QAM will downshift to 256QAM. The last ACM downshift will happen after exceeding 70.7% and the link will lose synchronization when *signal quality* reaches 54.3%.

When *signal quality* improves, upshift thresholds will be used. ACM will upshift back to 1024QAM when *signal quality* exceeds 81.3% at 512QAM modulation.



Signal quality value depends on the current Rx modulation. It is not possible to translate what would the current *signal quality* be at different Rx modulation.

Alternatively, ACM can also be used to increase the link distance, resulting in added link spectral efficiency. The same concept is implemented as previously, with the margins that were kept for 99.995-percent bandwidth availability now used to increase the link distance. Whenever the link conditions are degraded, the system will switch to an ACM profile with lower spectral efficiency to maintain link synchronization.

The following real-world example illustrates the benefits of ACM. Consider an Integra-W/Integra-WS link operating at 23 GHz with 60 MHz channel spacing an integrated antenna with 40.5 dBi (60cm/2ft) gain. The link is operating in a moderate rain zone G (30mm/h) a distance of 11.3 kilometers (7 miles).

The system operation is set to a minimal payload of 75Mbps (4QAM) Ethernet for 99.999% annual availability.

Most of the time system would operate at full capacity of 883Mbps (1024QAM) instead of 75 Mbps (4QAM). The system automatically monitors *signal quality* and changes the capacity without interrupting the data transmission and losing any frames (hitless).

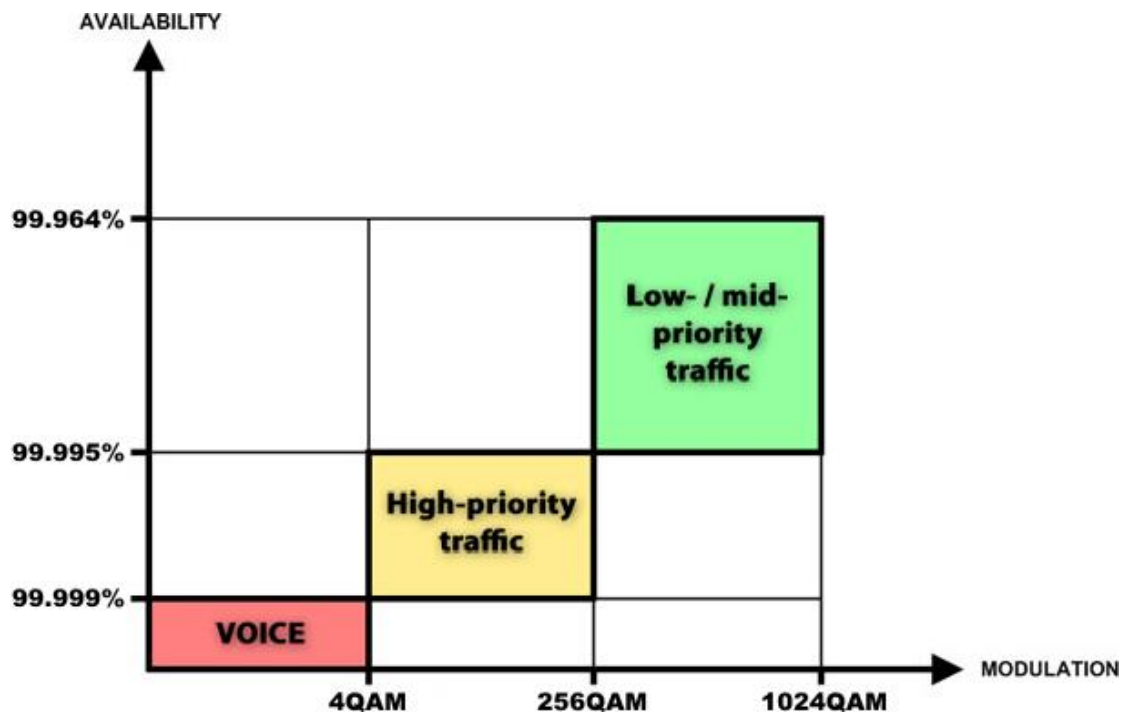

In comparison system using 1024QAM without ACM and providing similar capacity would offer only 99.964% of availability. You would have to decrease the distance, decrease modulation or increase antenna sizes to achieve 99.999% availability for the given link.

This example demonstrates how the new technology, based on an ACM mechanism, can play a key role in the development of cost-effective next-generation wireless access networks, by taking advantage of traffic evolution from synchronous TDM traffic to packet IP-based traffic.

ATPC (Automatic Transmit Power Control)

ACM can be implemented together with **automatic transmit power control (ATPC)**. ATPC reduces the average transmitted power as well as co-channel interference (CCI), and adjacent-channel interference (ACI), which is caused by extraneous power from a signal in an adjacent channel. It also enables a more efficient and cost-effective network frequency plan and deployment, as well as eliminating some of the receivers' "upfade" problems by changing the transmitted power according to the link momentary conditions. The lower average Tx power also extends the equipment's mean time between failures.

ATPC can be used together with ACM to control the transmitted power in any given ACM profile. Different configurations can be implemented to achieve maximal spectral efficiency or minimal transmitted power using both features in combination. One implementation could target maximal spectral efficacy by trying to reach the highest ACM profile, while the other is willing to compromise on some of the spectral efficiency enabling CCI and ACI reduction. In any chosen configuration, ATPC reduces the average transmitted power, benefiting each ACM profile and any link condition.

The local Integra receives information about Rx level from the far-end Integra through the service channel. Depending on the received Rx level parameter, the local Integra adjusts the transmitter power in accordance with the algorithm shown below.

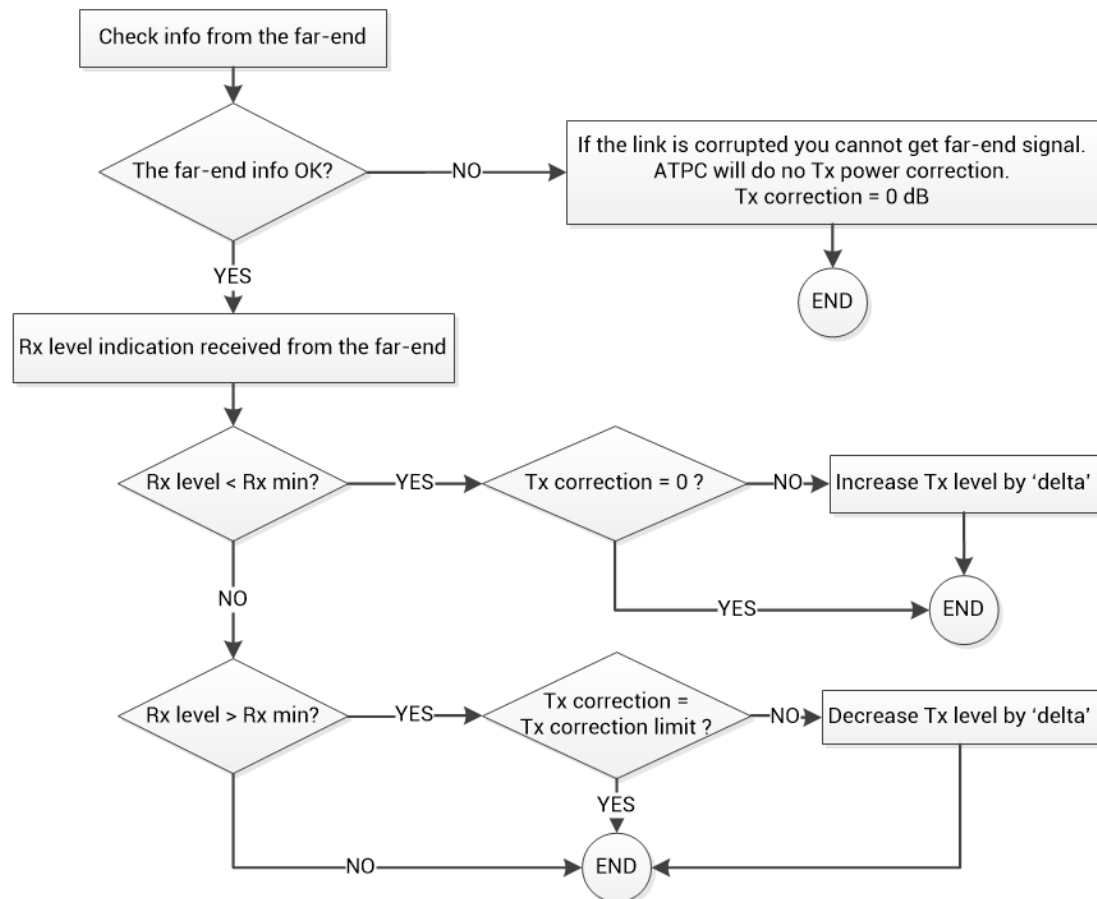

Rx level – the Rx level value received from the far-end site

Rx max – maximum permissible Rx level at the far-end site

Rx min – minimum permissible Rx level at the far-end site

Tx correction – value by what ATPC has decreased Tx power

Tx correction limit – defined maximum of Tx correction

Delta – the value by which Tx power is changed according to the far-end Rx level indication (1dB by default)

FTP directory

FTP directory of Integra-W/Integra-WS can be used in combination with CLI commands to backup/restore system configuration, upload another FW version, upload new license file.

FTP directory is separated area of internal memory in Integra-W/Integra-WS.

FTP directory function is deactivated by every restart of Integra-W/Integra-WS and all files from this special area are wiped out.

Use CLI command **system service ftp enable** to activate FTP directory function.

After system service ftp is enabled it is possible to connect to Integra-W/Integra-WS by using your favorite FTP client. Username is **anonymous** and password is empty.

Here is an example of FTP connection to Integra-W/Integra-WS using FileZilla:

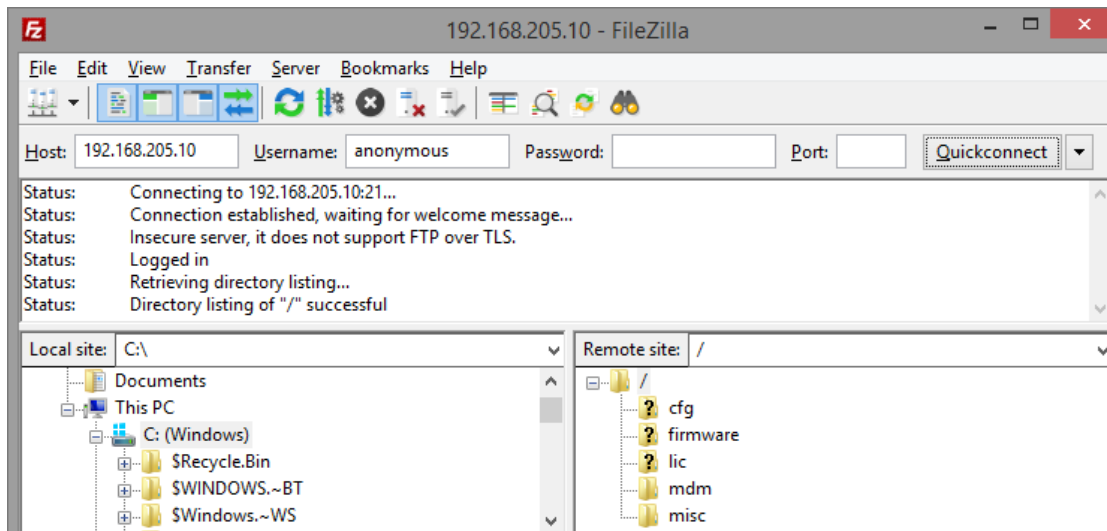

FTP area has a number of sub-directories separating every sub-function:

cfg	For managing system configuration backup/restore files. More information in the the chapter System → Configuration → Configuration file .
firmware	For uploading a firmware files. For more information see the chapter System → FW → Firmware upgrade and CLI commands of the chapter Over The Air → Radio → Configuration
lic	For uploading a license files. For more information see the chapter System → Tools → License management .
mdm	For service use only.
misc	For service use only.

After finishing your work with the FTP directory, deactivate it by CLI command: **system service ftp disable**.

Firmware upgrade management with SNMP

The firmware upgrade procedure can be performed using a set of SNMP read/write variables. This allows optimizing the process for a large number of radio units in a network.

The following steps describe the whole process.

- 1) Enable FTP server by setting (SNMP SET command) **integraWsystemServicesFtpSwitch** variable to "2".
- 2) Check if the FTP server is enabled by reading (SNMP GET command) the following variable: **integraWsystemServicesFtpSwitch**.
- 3) Transfer the required firmware file ("bin" file inside the FW package archive) to the "firmware" folder in the FTP directory (for more information, refer to chapter [FTP directory](#)). Use the following FTP address: ftp://anonymous@DEVICE_IP:/firmware/ (where *DEVICE_IP* should be substituted with the IP address of Integra-W/Integra-WS).
- 4) Initiate the upload of the transferred firmware file by setting **integraWsystemServicesFwUpload** variable to "1". Only a single firmware file is allowed to be present in the "firmware" folder during the upload. Please note that the command execution usually takes up to 30 seconds, and SNMP read/write requests will return the timeout error during this time. In about 30 seconds, the newly uploaded

- firmware should be seen in **integraWsystemServicesFwAvailView** list (see the next step) and available for installation.
- 5) View information about the firmware versions already available for installation by reading **integraWsystemServicesFwAvailView** variable: you will get a string containing index numbers and names of all firmware versions available for installation (n1: candfw1; n2: candfw2; etc.).
 - 6) As the memory allocated for the firmware files is limited, the upload can fail if there are several firmware versions already uploaded (maximum 5 files are permitted). The unnecessary items can be removed with **integraWsystemServicesFwRemove** variable (setting to "n", where "n" is the index number of selected firmware file from **integraWsystemServicesFwAvailView** list). All items can be removed by setting **integraWsystemServicesFwRemoveAll** variable to "1".
 - 7) Install the required candidate firmware by setting **integraWsystemServicesFwInst** variable to "n", where "n" is the index number of selected firmware file from **integraWsystemServicesFwAvailView** list. Please note that the installation execution usually takes up to 30 seconds, and SNMP read/write requests will return the timeout error during this time.
 - 8) In about 30 seconds, initiate system reboot by setting **integraWsystemServicesReboot** to "1".
 - 9) After the system reboots, check the current FW version by reading **integraWsystemServicesFwCurrInfo** variable.
 - 10) As an additional functionality, a user can switch between two firmware banks (fw1 and fw2) using **integraWsystemServicesFwSwitchNext** variable (setting to "1/2" for fw1/fw2 bank accordingly). This will change the firmware bank that will be used during the next startup. Currently used firmware bank can be viewed by reading **integraWsystemServicesFwSwitchRunning** variable. The firmware bank selected for the next startup can be checked by reading **integraWsystemServicesFwSwitchNext** variable. Please note that when firmware is installed it is assigned to a vacant bank (not occupied by the previously running firmware); this bank will be selected for the next startup automatically.

The description of the relevant OIDs is given in the table below:

integraWsystemServicesReboot (.1.3.6.1.4.1.7571.100.1.1.7.2.4.14.1)	WRITE	Set "1" to initiate system reboot.
integraWsystemServicesFtpSwitch (.1.3.6.1.4.1.7571.100.1.1.7.2.4.14.2)	READ-WRITE	Status and on/off switch for the FTP server (set "1/2" to disable/enable).
integraWsystemServicesFwCurrInfo (.1.3.6.1.4.1.7571.100.1.1.7.2.4.14.3)	READ-ONLY	Currently running FW information.
integraWsystemServicesFwAvailView (.1.3.6.1.4.1.7571.100.1.1.7.2.4.14.4)	READ-ONLY	List of the uploaded FW files available for installation.
integraWsystemServicesFwRemove (.1.3.6.1.4.1.7571.100.1.1.7.2.4.14.5)	WRITE	Set "n" to remove the n-th FW file from the uploaded FW list.
integraWsystemServicesFwRemoveAll (.1.3.6.1.4.1.7571.100.1.1.7.2.4.14.6)	WRITE	Set "1" to remove all FW files from the uploaded FW list.
integraWsystemServicesFwUpload (.1.3.6.1.4.1.7571.100.1.1.7.2.4.14.7)	WRITE	Set "1" to start the upload and make the FW available for installation.
integraWsystemServicesFwInst (.1.3.6.1.4.1.7571.100.1.1.7.2.4.14.8)	WRITE	Set "n" to install the n-th FW file from the uploaded FW list.
integraWsystemServicesFwSwitchRunning (.1.3.6.1.4.1.7571.100.1.1.7.2.4.14.9)	READ-ONLY	Currently running FW bank.
integraWsystemServicesFwSwitchNext (.1.3.6.1.4.1.7571.100.1.1.7.2.4.14.10)	READ-WRITE	The next startup FW bank (set "1/2" to change the FW bank for the next startup)

RADIUS authentication

Configuration of the RADIUS server authentication

Always check your RADIUS server documentation before modifying the RADIUS configuration.

RADIUS vendor ID for Integra equipment is **7571**.

The configuration of the FreeRADIUS software based on the Linux system (Ubuntu) is given below as an example. Keep in mind that there could be differences in command syntax and file locations between FreeRADIUS software versions, always check the FreeRADIUS documentation.

- 1) Add new user data to the users` configuration file: `/etc/freeradius/users`. Add the following line to the users` list:

```
user_1 Cleartext-Password := "pass_1"
```

where `user_1` is a user name and `pass_1` is a password.

```
# This is a complete entry for "steve". Note that there is no Fall-Through
# entry so that no DEFAULT entry will be used, and the user will NOT
# get any attributes in addition to the ones listed here.
```

```
user_1 Cleartext-Password := "pass_1"
#
#steve Cleartext-Password := "testing"
```

- 2) Add client (Integra) data by editing the clients` configuration file: `/etc/freeradius/clients.conf`. Add the following lines specifying Integra IP address and the RADIUS secret:

```
client 192.168.205.10 {
    secret = radiuspass_1
}
```

where `192.168.205.10` is the IP address of Integra, `radiuspass_1` is the RADIUS secret word.

```
# the "ipaddr" or "ipv6addr" fields. For compatibility, the 1.x
# format is still accepted.
#
```

```
client 192.168.205.10 {
secret = radiuspass_1
}
```

- 3) Restart FreeRADIUS.
- 4) Set up the RADIUS configuration in Integra Web GUI:
 - a. Open the RADIUS server configuration page ([System](#) → [Configuration](#) → [System services](#)).
 - b. Configure the RADIUS port, RADIUS server IP address, and RADIUS secret parameters according to your setup.



RADIUS server should belong to the same subnet as Integra and should have the same secret word as Integra.

RADIUS server configuration

RADIUS	<input checked="" type="checkbox"/> Enable
RADIUS port	<input type="text" value="1812"/>
RADIUS server IP address	<input type="text" value="192.168.205.1"/>
Set RADIUS secret (<33 characters)	<input type="password" value="....."/>
Confirm RADIUS secret (<33 characters)	<input type="password" value="....."/>
Hide password <input checked="" type="checkbox"/>	

- 5) Execute a configuration, save the configuration changes and reboot Integra.
- 6) Log in to Integra using the secure HTTPS connection.
- 7) Proceed to assigning administrative rights to a user if needed, see next chapter [Assigning administrator rights to a RADIUS user](#).

You can log in with users defined both locally and on the RADIUS server.

Assigning administrator rights to a RADIUS user

- 1) Add the corresponding attribute to the main FreeRADIUS dictionary file. Open the file: /etc/freeradius/dictionary and add the following line under the "Miscellaneous attributes...":

```

ATTRIBUTE      SAF-User-Level      52      string

#
#      If you want to add entries to the dictionary file,
#      which are NOT going to be placed in a RADIUS packet,
#      add them here.  The numbers you pick should be between
#      3000 and 4000.
#
ATTRIBUTE      SAF-User-Level      52      string
#ATTRIBUTE      My-Local-String      3000      string
#ATTRIBUTE      My-Local-IPAddr      3001      ipaddr
#ATTRIBUTE      My-Local-Integer      3002      integer
~
    
```

- 2) For providing the specified attribute to the user that must be granted administrator rights open the users` configuration file: /etc/freeradius/users and insert the following line below the definition of the user name and password:

SAF-User-Level = admin

For example:

user_1 *Cleartext-Password := "pass_1"*
SAF-User-Level = admin

```

# This is a complete entry for "steve". Note that there is no Fall-Through
# entry so that no DEFAULT entry will be used, and the user will NOT
# get any attributes in addition to the ones listed here.

user_1  Cleartext-Password := "pass_1"
        SAF-User-Level = admin

#
#steve  Cleartext-Password := "testing"
    
```

- 3) Restart FreeRADIUS.
- 4) Log in to Integra using the secure HTTPS connection.

Chapter 7: TOOLS

Link Layer Discovery tool

The Link Layer Discovery Tool is a command line application for MS Windows. It sends requests to LLD server application which runs on all Integra series devices.

The tool is used to discover Integra-W/Integra-WS devices and reset their passwords or settings.

The application runs on the following version of Windows: Windows Vista, Windows 7, Windows 8, and Windows 10.

[WinPCAP](#) must be installed to use the Link Layer Discovery Tool.

The Link Layer Discovery Tool for Integra series can be downloaded in <https://saftehnika.com/en/downloads> in “Tools” section. Login required.

- 1) Unzip the LLD.zip file you downloaded to a directory of your choice, for example, C:\SAF\LLD\.
- 2) The application is started via the command prompt (Start menu→Run→type “cmd”→press ENTER). The Command line console window should appear.

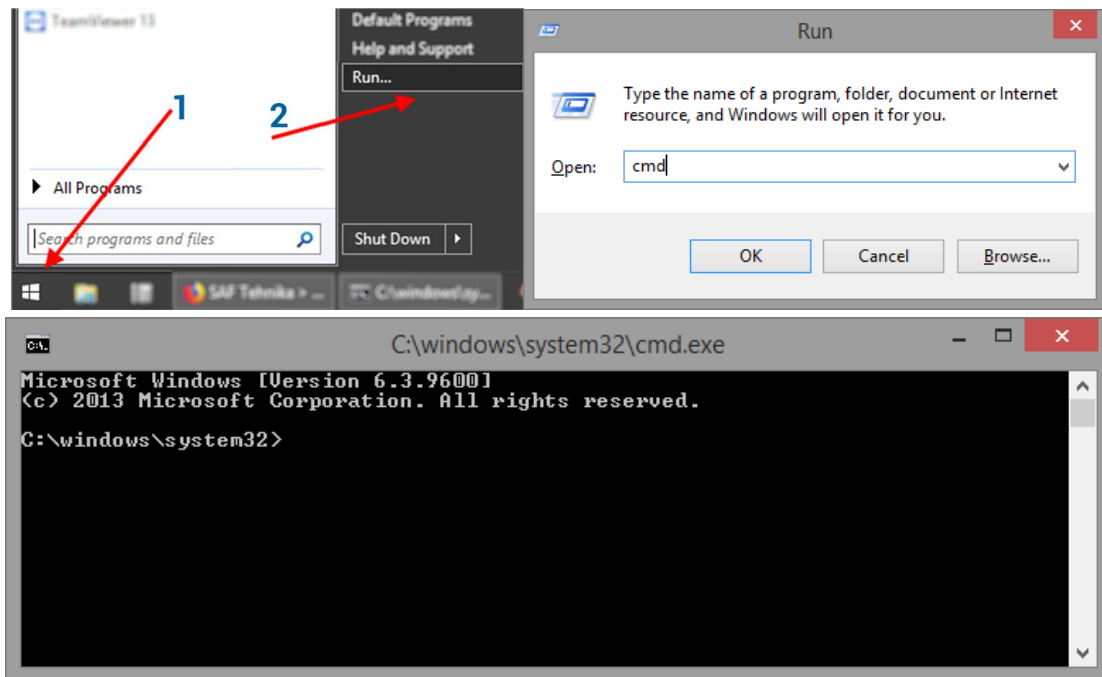

- 3) The default directory in the console is the current user directory. To change it, type:
cd <directory path>
For example:
cd c:\saf\lld
- 4) Run the recovery tool by typing “lld” without quotes in the console prompt and press ENTER.

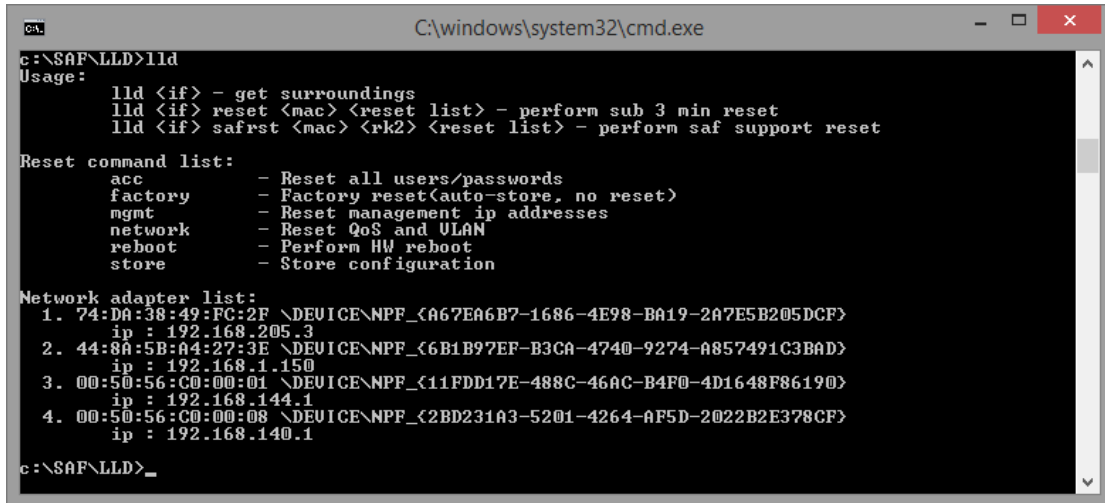

5) Available commands and network adapter list should be shown. To scan for Integra devices, the command should be run as follows:

lld <network interface>

For example:

lld \DEVICE\NPF_{A67EA6B7-1686-4E98-BA19-2A7E5B205DCF}

To copy the interface address from the network adapter list, click the right mouse button over the console and select "Mark":

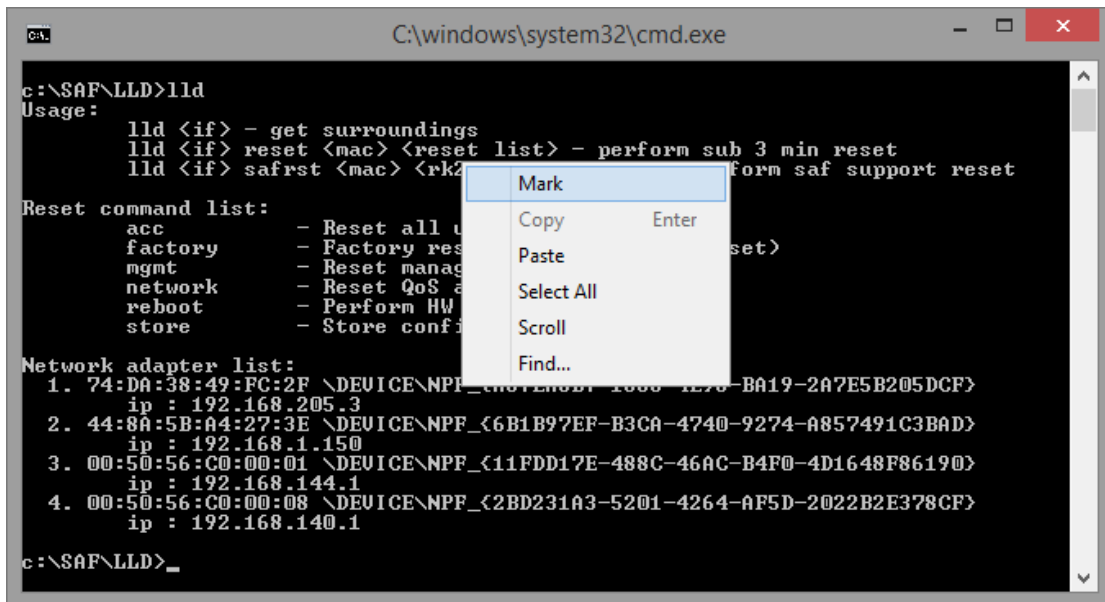

Then by holding the left button select the interface address:

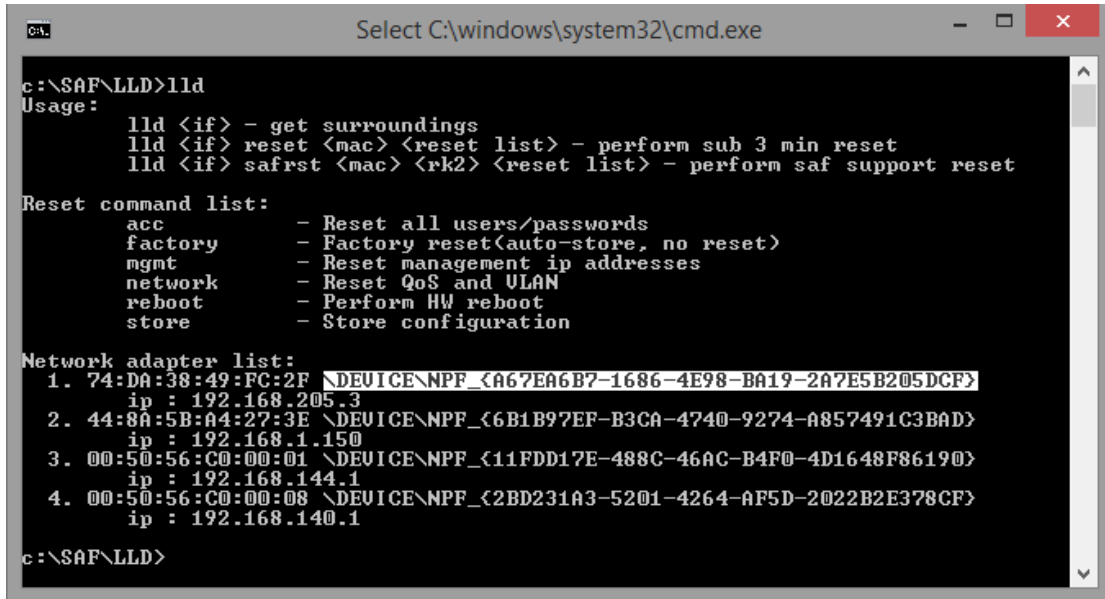

After selecting, release the left button and click the mouse right button anywhere on the console. The address should be copied.

Type "lld" and paste the address by clicking the right button anywhere on the console:

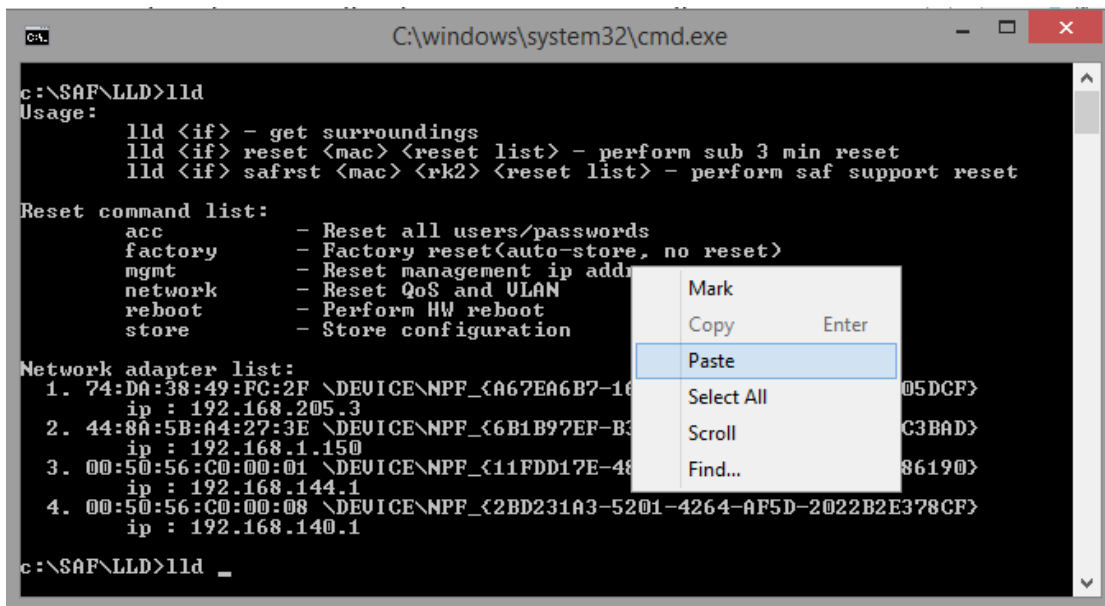

The result should be similar as in the image below:

```

C:\windows\system32\cmd.exe

c:\SAF\LLD>lld
Usage:
  lld <if> - get surroundings
  lld <if> reset <mac> <reset list> - perform sub 3 min reset
  lld <if> safrst <mac> <rk2> <reset list> - perform saf support reset

Reset command list:
  acc          - Reset all users/passwords
  factory      - Factory reset(auto-store, no reset)
  mgmt         - Reset management ip addresses
  network      - Reset QoS and VLAN
  reboot       - Perform HW reboot
  store        - Store configuration

Network adapter list:
  1. 74:DA:38:49:FC:2F \DEVICE\NPF_{A67EA6B7-1686-4E98-BA19-2A7E5B205DCF}
     ip : 192.168.205.3
  2. 44:8A:5B:A4:27:3E \DEVICE\NPF_{6B1B97EF-B3CA-4740-9274-A857491C3BAD}
     ip : 192.168.1.150
  3. 00:50:56:C0:00:01 \DEVICE\NPF_{11FDD17E-488C-46AC-B4F0-4D1648F86190}
     ip : 192.168.144.1
  4. 00:50:56:C0:00:08 \DEVICE\NPF_{2BD231A3-5201-4264-AF5D-2022B2E378CF}
     ip : 192.168.140.1

c:\SAF\LLD>lld \DEVICE\NPF_{A67EA6B7-1686-4E98-BA19-2A7E5B205DCF}
    
```

- 6) Press ENTER and the recovery tool will now scan for Integra devices. Available devices and their information will appear in the console. Make sure that the device has finished booting up.

```

C:\windows\system32\cmd.exe

c:\SAF\LLD>lld \DEVICE\NPF_{A67EA6B7-1686-4E98-BA19-2A7E5B205DCF}
Collecting surrounding data...
Dev #0
Dev #1
      RK1 : C92EDA814D68F97AD507628F17BE194F08ABA11F
      RK1 fresh : false
      device name : SAF
      model : Integra-S
      product number : D17BSR01H
      sw version : fw1 / 3.7.6
      MAC : 0004A6813773
      ip address : 192.168.205.111
      ip mask : 255.255.255.0

c:\SAF\LLD>
    
```

- 7) Use the MAC address of the device with the reset command to reset this specific device. The MAC address can be copied the same way as the interface address.

```

C:\windows\system32\cmd.exe

c:\SAF\LLD>lld \DEVICE\NPF_{A67EA6B7-1686-4E98-BA19-2A7E5B205DCF}
Collecting surrounding data...
Dev #0
Dev #1
      RK1 : C92EDA814D68F97AD507628F17BE194F08ABA11F
      RK1 fresh : false
      device name : SAF
      model : Integra-S
      product number : D17BSR01H
      sw version : fw1 / 3.7.6
      MAC : 0004A6813773
      ip address : 192.168.205.111
      ip mask : 255.255.255.0

c:\SAF\LLD>
    
```

- 8) The device is reset by using the required reset command with the recovery tool:

lld <interface> reset <MAC> <reset command>

where *<interface>* - network interface from the network adapter list;

<MAC> - required Integra device address;

<reset command> - reset options.

Different reset options are available depending on the reset requirement. Reboot and store options are also available. Store option saves the device current configuration so it will be restored after system reboot. The commands are available in the reset command list. Use the command after the MAC address of the device as shown in the previous reset command example.

```
Reset command list:
acc          - Reset all users/passwords
factory      - Factory reset(auto-store, no reset)
mgmt         - Reset management ip addresses
network      - Reset QoS and ULAM
reboot       - Perform HW reboot
store        - Store configuration
```

For example, to reset users and passwords on Integra device #1, use:

```
lld \DEVICE\NPF_{A67EA6B7-1686-4E98-BA19-2A7E5B205DCF} reset 0004A6813773 acc
```

Make sure the command is run within 3 minutes after Integra reboot ("RK1 fresh" must be "true" in the console), otherwise error shown in the screenshot below error will occur. The recovery tool will continue to retry the command.

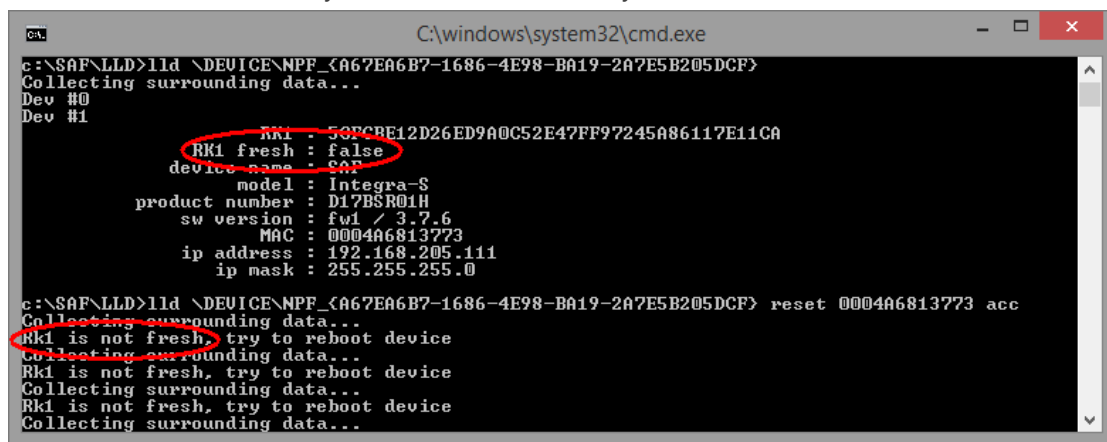

Power down the Integra device and power it up again, the reset should be completed soon.

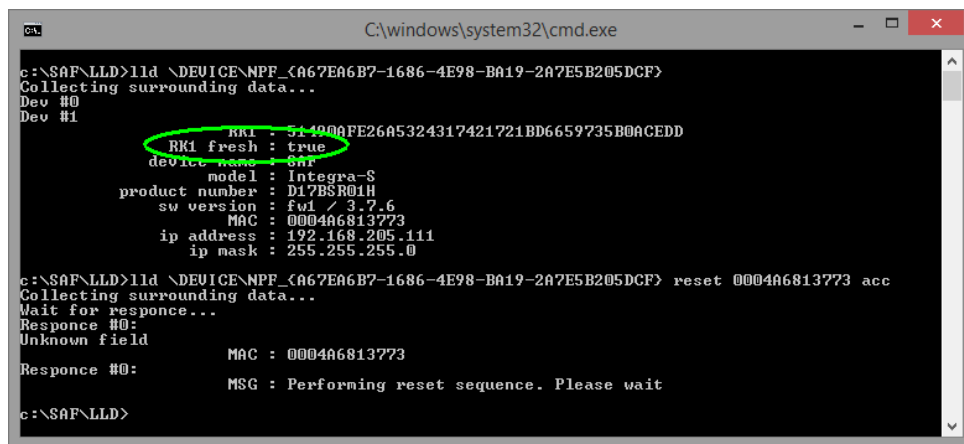

If the reset cannot be completed, redo step 8.

- 9) Store changes by command (must be done within the time frame of 3 minutes after boot) or by using WEB GUI (any time before the Integra device is powered off) "SAVE" button.

For example:

```
lld \DEVICE\NPF_{A67EA6B7-1686-4E98-BA19-2A7E5B205DCF} reset 0004A6813773 store
```

```

C:\windows\system32\cmd.exe
c:\SAF\LLD>lld \DEVICE\NPF_{A67EA6B7-1686-4E98-BA19-2A7E5B205DCF} reset 0004A6813773 mgmt
Collecting surrounding data...
Wait for response...
Response #0:
Unknown field
Response #0:          MAC : 0004A6813773
Response #0:          MSG : Performing reset sequence. Please wait
c:\SAF\LLD>lld \DEVICE\NPF_{A67EA6B7-1686-4E98-BA19-2A7E5B205DCF} reset 0004A6813773 store
Collecting surrounding data...
Wait for response...
Response #0:
Unknown field
Response #0:          MAC : 0004A6813773
Response #0:          MSG : Performing reset sequence. Please wait
c:\SAF\LLD>_
    
```

Main			MODIFY
System	Local	Remote	SAVE 1
License remaining time	Unlimited	Unlimited	
Radio	Local	Remote	
Radio side	Low	High	LOGOUT

MIB files



Relevant MIB files can be downloaded directly from Integra-W/Integra-WS Web GUI. See Chapter “System → Configuration → SNMP configuration” for further details.

Chapter 8: INTERFACES

RJ-45 ports (MNG & LAN)

RJ-45 ports (MNG & LAN) comply with IEEE 802.3-2005 1000Base-T Ethernet and LTPoE++ Power over Ethernet standards. MNG port additionally complies with 100Base-T Ethernet standard.



For some HW revisions, PoE may be available on the data (LAN(TP)) port only.

The pinouts are as follows:

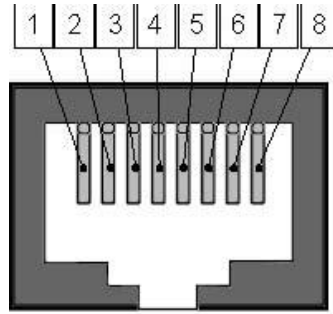

Pin	Data	PoE
1	Bi-directional A+	VB1+
2	Bi-directional A-	VB1+
3	Bi-directional B+	VB1-
4	Bi-directional C+	VB2+
5	Bi-directional C-	VB2+
6	Bi-directional B-	VB1-
7	Bi-directional D+	VB2-
8	Bi-directional D-	VB2-



PoE power polarity can be reversed.

In case an Ethernet cable is used for power & data (with PoE injector), the combined Ethernet cable length from the PoE injector to Integra-W/Integra-WS FODU and from the PoE injector to CPE is limited to 100m / 328ft.

In case the SFP interface (LAN) is configured for data traffic, it is possible to use the RJ-45 port solely for power supply. Two options are possible:

- 1) Ethernet cable with PoE injector.

Please refer to the table below for the maximum Ethernet cable length from the PoE injector to Integra-W/Integra-WS FODU based on AWG wire size and Integra-W/Integra-WS FODU power consumption.

AWG	Lmax @ 75W	Lmax @ 55W	Lmax @ 35W
26	129m / 423ft	176m / 577ft	277m / 907ft
24	205m / 673ft	280m / 918ft	440m / 1442ft
22	326m / 1071ft	445m / 1460ft	699m / 2294ft

- 2) 2-wire power cable together with DC power adapter cable for Integra-W/Integra-WS (P/N D0ACPW01).

Please refer to the tables below for the maximum power cable length based on AWG wire size or cross-section and Integra-W/Integra-WS FODU power consumption.

AWG	Lmax @ 75W	Lmax @ 55W	Lmax @ 35W
24	51m / 168ft	70m / 229ft	110m / 361ft
22	82m / 268ft	111m / 365ft	175m / 574ft
20	132m / 423ft	180m / 589ft	282m / 926ft
18	206m / 675ft	281m / 920ft	441m / 1446ft
16	329m / 1080ft	449m / 1473ft	705m / 2314ft
14	527m / 1728ft	718m / 2356ft	1129m / 3703ft

Cross-section area	Lmax @ 75W	Lmax @ 55W	Lmax @ 35W
0.25mm ²	64m / 211ft	88m / 288ft	138m / 452ft
0.5mm ²	129m / 422ft	175m / 575ft	276m / 904ft
0.75mm ²	193m / 633ft	263m / 863ft	413m / 1356ft
1.0mm ²	251m / 824ft	342m / 1124ft	538m / 1766ft
1.5mm ²	376m / 1232ft	512m / 1681ft	805m / 2641ft



Maximum cable length calculation is done using copper resistance.

SFP port (LAN)

SFP port provides SFP transceiver connectivity.

SFP port complies with the following Gigabit Ethernet standards:

1000BASE-SX, 1000BASE-LX, 1000Base-T (note: 1000FDX only).



Inquire SAF representative about compatible SFP modules.

In the case of third-party modules, inquire SAF representative about the testing possibility.

USB port

USB port provides serial terminal access to CLI. The socket is B type.

USB Type B Socket

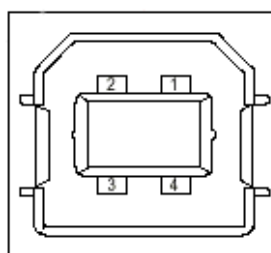

1=Vbus (5V)

2=D-

3=D+

4=GND

RSSI LED

RSSI LED can be activated in three operational modes – Mode 1, Mode 2, and Mode 3. By default, RSSI LED is enabled in Mode 1. For further details please refer to the [Over The Air → Radio → Configuration](#) page.

Corresponding Rx signal levels and LED blinking pattern for each mode is represented in the figure below:

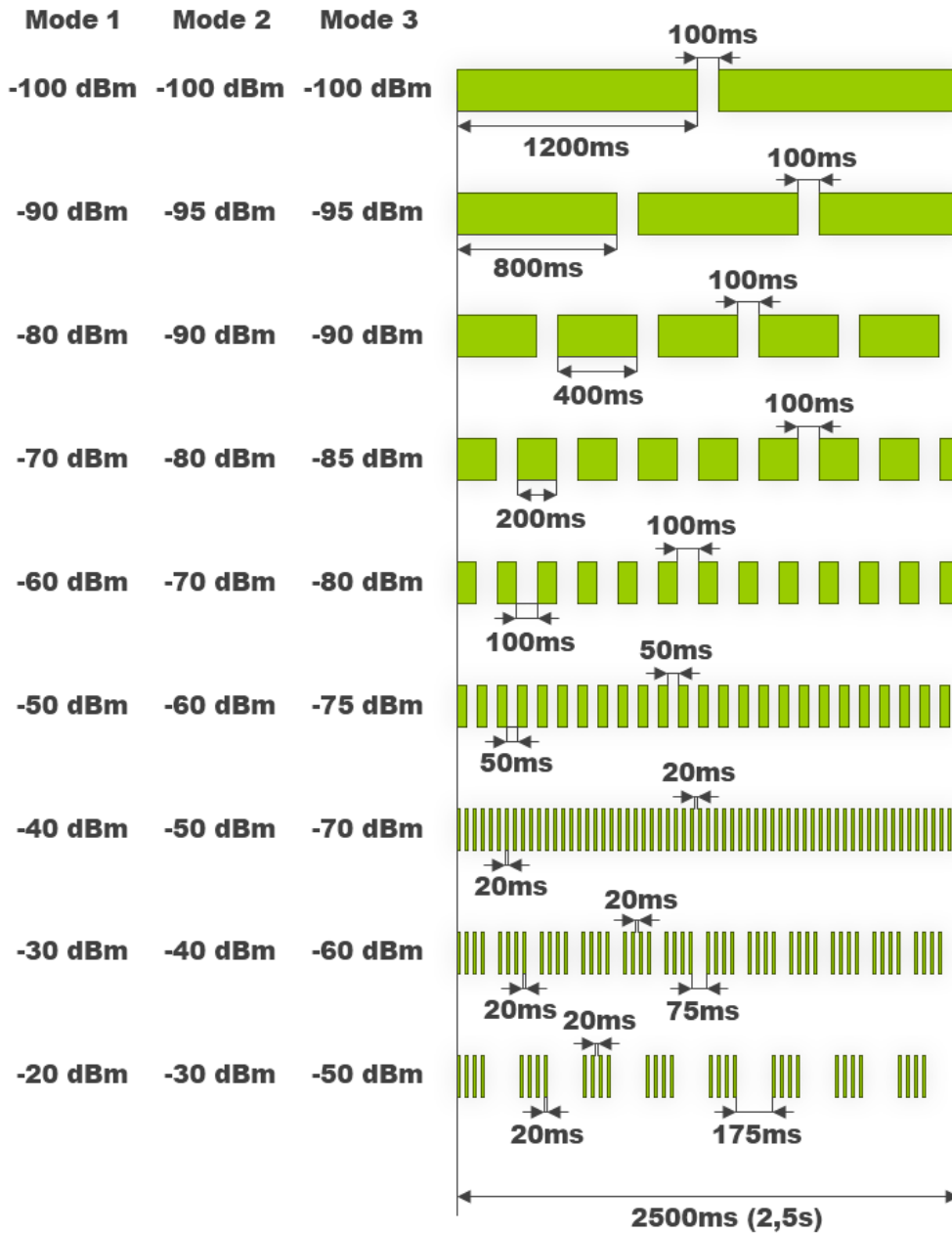

Integra-WS RSSI LED description

The 15-42 GHz Integra-WS FODUs have a dual-color RSSI LED. The RSSI LED can blink either in green or red color. The blinking pattern is as given in the figure above and is the same for both colors. (Functionality may not be available in older HW revisions.)

A red RSSI LED warns about mistakes in the FODU installation. It turns red in the following circumstances:

- 1) If the polarization offset from the vertical polarization axis (zero degrees level) is more than 3 degrees to both sides.

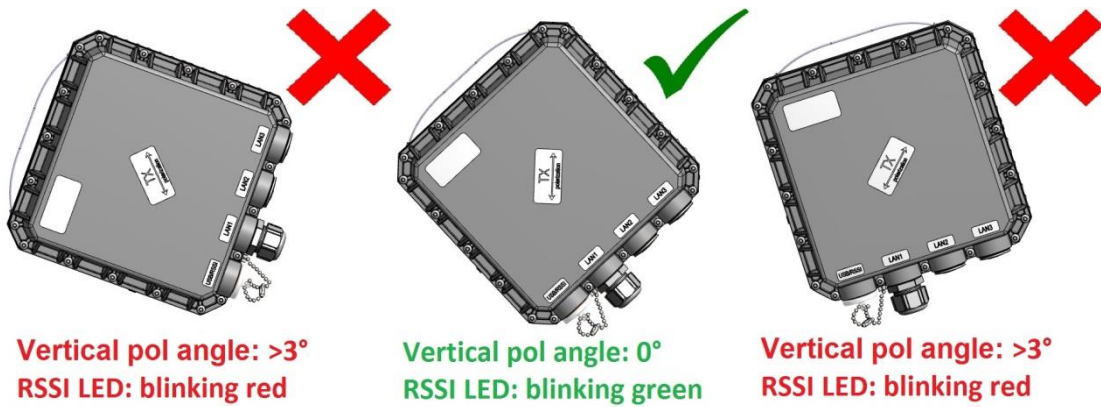

- 2) If the polarization offset from the horizontal polarization axis (zero degrees level) is more than 3 degrees to both sides.
- 3) If the elevation angle of the Integra-WS FODU will differ for more than +/-20 degrees from zero degrees elevation angle.



- 4) If the FODU will be installed with its interfaces upwards.

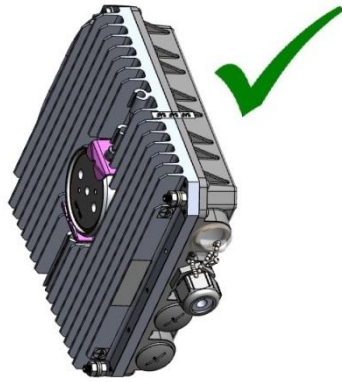

Interfaces faced down
RSSI LED: blinking green



Interfaces faced up
RSSI LED: blinking red

- 5) If the FODU will be placed on any surface horizontally.



Horizontal position
RSSI LED: blinking red



Note that 17&24 GHz Integra-WS FODUs must be installed in opposite polarizations.

RSSI/audio port

RSSI (Received Signal Strength Indicator) port is used to adjust the alignment of the antenna for best performance (for both rough and fine adjustment); this can be done using a digital multimeter or headphones connected to the RSSI port. The RSSI port is a 3.5mm socket. The output of the RSSI port is DC voltage and audio frequency and varies depending on the received signal level. Both are linear curves.

To connect a voltmeter, you will require the appropriate RSSI cable (P/N D0ACRS01):



RSSI cable has a 3.5mm RSSI/audio jack with the pinout shown below:

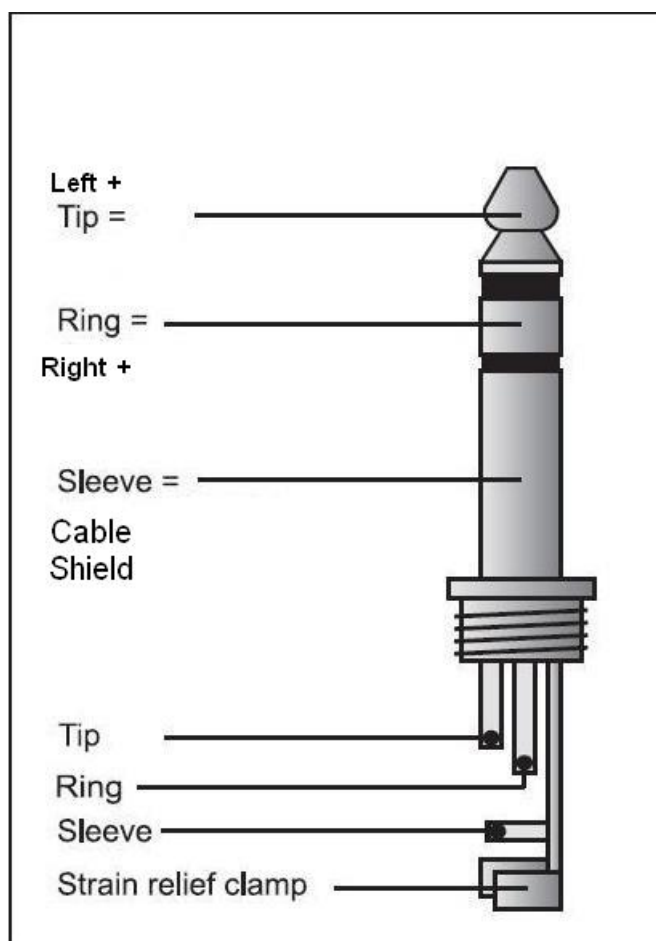

The following charts and tables show the typical relationship of the received signal level (Rx level) displayed by Integra-W/Integra-WS vs. RSSI port output voltage (RSSI – Received Signal Strength Indicator) and audio frequency. The RSSI port is located on FODU. The evaluated Rx level has an error of +/-2 dB.

Output voltage

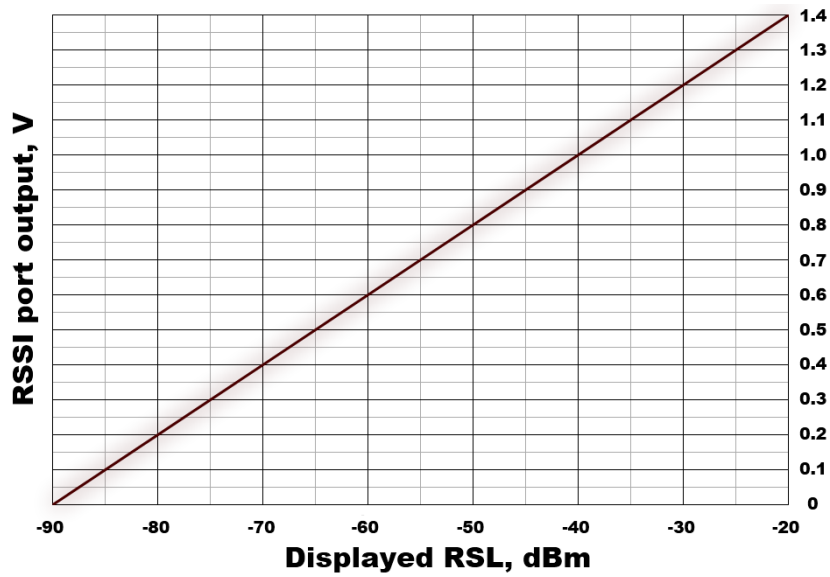

Rx level (dBm)	RSSI voltage (V)
-90	0
-85	0.1
-80	0.2
-75	0.3
-70	0.4
-65	0.5
-60	0.6
-55	0.7
-50	0.8
-45	0.9
-40	1.0
-35	1.1
-30	1.2
-25	1.3
-20	1.4

Output audio frequency

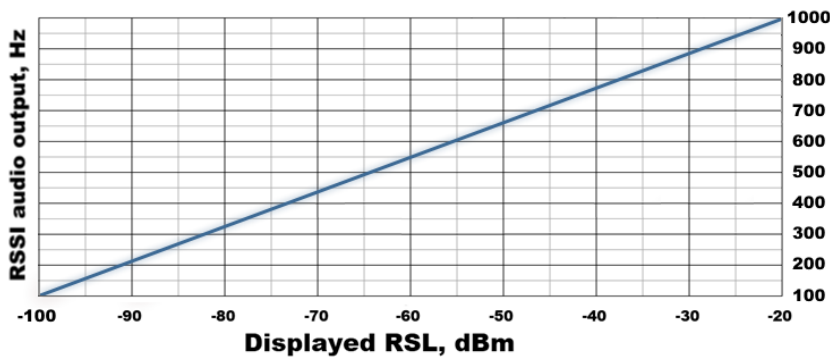

Rx level (dBm)	Audio frequency (Hz)
-100	100
-96	145
-92	190
-88	235
-84	280
-80	325
-76	370
-72	415
-68	460
-64	505
-60	550
-56	595
-52	640
-48	685
-44	730
-40	775
-36	820
-32	865
-28	910
-24	955
-20	1000

Grounding connection

Always provide a good connection from the FODU grounding screw to the tower/mast/building grounding circuit or body. You must choose one, the most convenient, of 2 screws for grounding connection.



Appendix A: TECHNICAL SPECIFICATION

General		
Concept / form factor	FODU (Full-outdoor unit), directly mounted to the antenna	
Radio standards	EN 302 217-2 v3.1.1, EN 300 t+40-2 v1.4.1, FCC CFR 47 Part 101, Industry Canada RSS-GEN and relevant SRSP Specifications	
Capacity	883 Mbps at 112 MHz 1024 QAM 643 Mbps at 80 MHz 1024 QAM (for Integra-W 17GHz and 24GHz)	
Frequency bands	6GHz, 11GHz, 15GHz, 17GHz UL, 18GHz, 23GHz, 24GHz UL, 26GHz, 28GHz, 38GHz, <i>and more*</i>	
Modulation	From 4QAM up to 1024QAM with hitless ACM	
Configurations	1+0	
ATPC and ATPC	Yes	
Channel bandwidth	ETSI: from 56 MHz up to 112 MHz FCC: from 40 MHz up to 80 MHz	
Frequency stability	± 10 ppm	
Ports		
Gigabit Ethernet	2x RJ-45	Electrical with built-in PoE splitter and surge arrestor
	1x SFP	Alternative to 1xRJ-45
Service ports	3.5mm	Audible alignment and RSSI
	USB B	RS232 serial over USB B-Type
	LED	Power On, Link Synchronization, RSL, Polarization accuracy*
Ethernet		
Ethernet	Unmanaged Gigabit Ethernet with only one simultaneous traffic port	
Gigabit Switch functionality	Transparent	
Management	SNMP v1/2c/3, SSH, Telnet, HTTPS, Serial, RADIUS, Network Time Protocol	
Performance monitoring	Performance graphs, constellation diagram, alarms, detailed counters	
Management	Both In-band and Out-of-band MNG	
Carrier Ethernet functionality	Transparent	
Jumbo frames	Yes, 9600 bytes	
Electrical		
Power consumption	31...74 W depending on model and frequency band. See table below.	
Power range	Integra	36 ... 57 V DC
	PoE Injector ¹	36 ... 60 V DC all Integra models; 22...60 V DC models with ≤50 W consumption
Temperature range	-33 ... +55 °C / -28 ... +130 °F	

¹ Voltage range using IOATPI24 Power over Ethernet Injector

* Inquire SAF representative for more information

Mechanical & environmental specification

Antenna type	External antenna (default)	0.3m / 1ft, integrated	0.6m / 2ft, integrated
Antenna interface	SAF2R 6...13 GHz SAF2 15...38 GHz	Integrated antenna, factory assembled with radio <i>(discontinued solution, no more available)</i>	
Stationary use	Conforms to ETSI EN 300 019 Class 4.1, NEMA 4X		
IP class	IP66		
Relative Humidity	15 to 90-100% @ 30°C		
Temperature range	-33...+55 °C / -28...+130 °F		
Size, 15GHz and higher, w/o mount	235 x 250 x 72 mm / 9.26" x 9.85" x 2.84"	378 x 378 x 227 mm / 14.9" x 14.9" x 9"	669 x 669 x 289 mm / 26.3" x 26.3" x 11.4"
Size, 17/24 GHz UL	235 x 250 x 111 mm / 9.26" x 9.85" x 4.37"	N/A	N/A
Size, 6...13 GHz	280 x 437 x 100 mm / 11.02" x 17.2" x 3.9"	N/A	N/A
Weight, 15GHz and higher, w/o mount	2.9 kg / 6.4 lbs	5 kg / 11 lbs	5 kg / 11 lbs
Weight, 17/24 GHz UL	4.9 kg / 10.8 lbs	N/A	N/A
Weight, 6...13 GHz	6.5 kg / 14.3 lbs	N/A	N/A
Mount	Mount size	292 x 176 x 250 mm / 11.5" x 7" x 10" max	
	Pole size	Mount on antenna Ø 40 – 120 mm / Ø 1.6" – 4.7"	
	Weight	2.55 kg / 5.6 lbs	

Power consumption and rated current at 36 – 57 V DC²

Model	L6 GHz	U6, GHz	11 GHz	15 GHz	17 GHz	18 GHz	23 GHz	24 GHz	26, 28 GHz	38 GHz	
Integra-W	Power [W] @ 36–57V DC	70	64	51	31	28	35	35	30	36	38
	Current [A] @ 36 V DC	1.9	1.8	1.4	0.9	0.8	1.0	1.0	0.8	1.0	1.1
	Current [A] @ 48 V DC	1.5	1.3	1.1	0.6	0.6	0.7	0.7	0.6	0.8	0.8
	Current [A] @ 57 V DC	1.2	1.1	0.9	0.5	0.5	0.6	0.6	0.5	0.6	0.7

² Power consumption for Integra radio shown only. For power consumption of complete system add up to 8% (at 48V DC input) for PoE in DC/DC mode, around 4W for 100m cable (depends on cable) and approx. 1W for SFP transceiver, if used.

Integra-W RSL Thresholds at BER 10⁻⁶ and Total Payload Capacity (Mbps)

		6L	6U	11	15	17	18	23	24	26	28	38	
		GHz	GHz	GHz	GHz	GHz	GHz	GHz	GHz	GHz	GHz	GHz	
BW, MHz	Modulation, Strong FEC	Guaranteed RSL Threshold, dBm											Capacity, Mbps
40	4QAM	-82.5	-82.5	-82.5	-82	-79	-83.5	-80.5	-80	-82	-82.5	-79	63
	8QAM	-79	-79	-78	-77.5	-76	-80.5	-76.5	-75.5	-78	-78.5	-75	94
	16QAM	-76	-76	-75.5	-75	-73	-76.5	-74.5	-72.5	-75	-74.5	-72.5	126
	32QAM	-73	-73	-73	-72.5	-70	-74	-71.5	-70	-72	-72	-69.5	157
	64QAM	-70	-70	-70	-69.5	-67.5	-71.5	-69.5	-66.5	-69	-69	-66.5	189
	128QAM	-67	-67	-67	-66.5	-64.5	-68	-65.5	-64	-66	-66.5	-63.5	220
	256QAM	-64	-64	-64	-63.5	-61	-63.5	-62.5	-60.5	-63	-61.5	-60.5	252
	512QAM	-61	-61	-60	-59.5	-58	-59.5	-59.5	-57.5	-60	-59.5	-57.5	284
	1024QAM	-57	-57	-56.5	-56	-55	-55.5	-57	-54	-56	-55.5	-53	315
	50	4QAM	-82	-82	-82	-81.5	-79	-82.5	-79.5	-79	-81	-81	-78.5
8QAM		-78	-78	-77	-76.5	-75	-79	-75.5	-75	-77	-77	-74.5	118
16QAM		-75	-75	-75	-74.5	-72	-76.5	-74.5	-72	-74	-74	-72	157
32QAM		-72	-72	-72	-71.5	-69.5	-73.5	-71.5	-69	-71	-71	-69	197
64QAM		-69	-69	-69	-68.5	-66.5	-70.5	-68.5	-66	-68	-68.5	-66	236
128QAM		-66	-66	-66	-65.5	-63.5	-65.5	-65.5	-62.5	-65.5	-66.5	-64	276
256QAM		-63	-63	-63	-62.5	-60	-62.5	-61.5	-60	-62	-62	-60	315
512QAM		-60	-60	-60	-59.5	-57.5	-58.5	-58.5	-57	-59	-59	-57	355
1024QAM		-56	-56	-56	-55.5	-54	-55.5	-55.5	-53	-55	-54.5	-52.5	394
56		4QAM	-81.5	-81.5	-81	-80.5	-78.5	-82.5	-80	-78	-80	-80.5	-77.5
	8QAM	-77	-77	-76	-75.5	-74.5	-78	-75.5	-73	-76	-76.5	-73.5	134
	16QAM	-74.5	-74.5	-74	-73.5	-72	-75.5	-74	-71	-74	-74	-71	178
	32QAM	-71.5	-71.5	-71	-70.5	-69	-72.5	-70.5	-68.5	-71	-71.5	-69.5	224
	64QAM	-68.5	-68.5	-68.5	-68	-66	-68.5	-67.5	-65	-68	-68	-66	269
	128QAM	-65	-65	-65	-64.5	-63	-65.5	-65	-62	-65	-65	-62	314
	256QAM	-62.5	-62.5	-62.5	-62	-60	-61.5	-61.5	-59	-62	-62.5	-59.5	359
	512QAM	-59.5	-59.5	-59	-58.5	-57	-58.5	-58.5	-56	-58	-59	-56	404
	1024QAM	-55	-55	-55.5	-55	-53	-54.5	-55	-52.5	-55	-55.5	-52.5	449
	60	4QAM	-81	-81	-81	-80.5	-78.5	-81.5	-80.5	-78	-80	-80	-77.5
8QAM		-76.5	-76.5	-76	-75.5	-74	-78	-75.5	-74	-76	-76	-73.5	144
16QAM		-74.5	-74.5	-74	-73.5	-71.5	-75.5	-73.5	-71	-74	-74.5	-72	192
32QAM		-71.5	-71.5	-71	-70.5	-68.5	-72.5	-70.5	-68	-71	-71.5	-68.5	240
64QAM		-68.5	-68.5	-67.5	-67	-64.5	-67.5	-67.5	-65	-67	-67	-65	288
128QAM		-65	-65	-65	-64.5	-62.5	-65.5	-64.5	-62	-65	-65.5	-62.5	336
256QAM		-62.5	-62.5	-62	-61.5	-59.5	-61.5	-61.5	-59	-61	-61.5	-58.5	385
512QAM		-59	-59	-58	-57.5	-56.5	-58.5	-58.5	-55.5	-58	-58	-56	433
1024QAM		-55	-55	-55	-54.5	-53	-54.5	-55	-52	-55	-54.5	-52	481
80		4QAM	-79.5	-79.5	-79.5	-79	-77.5	-81	-78.5	-76	-79	-79	-76.5
	8QAM	-75.5	-75.5	-74	-73.5	-72.5	-77	-75	-73	-75	-75	-72.5	192
	16QAM	-72.5	-72.5	-72	-71.5	-70	-74.5	-71.5	-70	-72	-72	-69.5	257
	32QAM	-69.5	-69.5	-69	-68.5	-67.5	-71.5	-68.5	-67	-69	-69	-66.5	321
	64QAM	-66.5	-66.5	-66.5	-66	-64.5	-67.5	-65.5	-64	-66	-66	-63.5	385
	128QAM	-63.5	-63.5	-63.5	-63	-61	-64	-62.5	-61	-63	-63	-60.5	450

		6L GHz	6U GHz	11 GHz	15 GHz	17 GHz	18 GHz	23 GHz	24 GHz	26 GHz	28 GHz	38 GHz		
BW, MHz	Modulation, Strong FEC	Guaranteed RSL Threshold, dBm											Capacity, Mbps	
	256QAM	-60.5	-60.5	-60.5	-60	-58	-60.5	-59.5	-58	-60	-60	-57.5	514	
	512QAM	-57.5	-57.5	-57	-56.5	-55	-57	-56.5	-54	-56.5	-56.5	-54	578	
	1024QAM	-53.5	-53.5	-53.5	-53	-51.5	-53.5	-53	-51	-53.5	-53.5	-51	643	
100 ³	4QAM	-78.5	-78.5	-79	-78.5	-	-80	-77.5	-	-78.5	-78.5	-76	168	
	8QAM	-74.5	-74.5	-74	-73.5	-	-76	-73.5	-	-73.5	-73.5	-71	252	
	16QAM	-71.5	-71.5	-71	-70.5	-	-73	-70.5	-	-71.5	-71.5	-69	336	
	32QAM	-68.5	-68.5	-69	-68.5	-	-70	-67.5	-	-68.5	-68.5	-66	420	
	64QAM	-65.5	-65.5	-65.5	-65	-	-66	-64.5	-	-65.5	-65.5	-63	504	
	FCC	128QAM	-63	-63	-63	-62.5	-	-63	-61.5	-	-62.5	-62.5	-60	588
	256QAM	-59.5	-59.5	-59.5	-59	-	-60	-58.5	-	-58.5	-58.5	-56	672	
	512QAM	-56	-56	-56	-55.5	-	-56	-55.5	-	-56.5	-56.5	-54	756	
	1024QAM	-52	-52	-51	-50.5	-	-51.5	-52	-	-51.5	-51.5	-49	840	
	112 ³	4QAM	-78.5	-78.5	-77.5	-77	-	-79.5	-77.5	-	-77.5	-77.5	-75	176
8QAM		-73.5	-73.5	-73.5	-73	-	-76	-73	-	-73	-73	-70.5	265	
16QAM		-71.5	-71.5	-71	-70.5	-	-73	-70.5	-	-70.5	-70.5	-68	359	
32QAM		-68.5	-68.5	-68	-67.5	-	-70	-67.5	-	-67.5	-67.5	-65	441	
64QAM		-65	-65	-65	-64.5	-	-66	-64.5	-	-64.5	-64.5	-62	530	
ETSI		128QAM	-62.5	-62.5	-62	-61.5	-	-63	-61.5	-	-61.5	-61.5	-59	618
256QAM		-59.5	-59.5	-59	-58.5	-	-59	-58.5	-	-58.5	-58.5	-56	707	
512QAM		-54.5	-54.5	-56	-55.5	-	-56	-54.5	-	-54.5	-54.5	-52	795	
1024QAM		-52	-52	-51.5	-51	-	-51.5	-51	-	-51.5	-51.5	-49	883	

³ 100 MHz and 112 MHz channel bandwidths are available for all Integra-W models except 17GHz and 24GHz UL.

Maximum Tx Power for Integra-W⁴

Modulation	Tx power, dBm						
	L6 GHz	U6 GHz	11 GHz	15, 18, 23, 26, 28 GHz	17 GHz ⁶ , 24 GHz ⁶	38 GHz	
4 QAM	+33	+31	+28	+22	-26 ... +5	+17	
16 QAM	+32	+30	+27	+21	-26 ... +5	+16	
32 QAM	+31	+29	+26	+21	-26 ... +5	+16	
64 QAM	+30	+28	+25	+20	-26 ... +5	+15	
128 QAM	+30	+28	+25	+20	-26 ... +5	+15	
256 QAM	+30	+28	+25	+19	-26 ... +5	+14	
512 QAM	+30	+28	+25	+19	-26 ... +5	+14	
1024 QAM	+28	+26	+23	+17	-26... +5	+12	

⁴ Max Tx power settings depend on EIRP allowed by national regulatory and antenna size.

High Performance integrated antenna specification

Size	Frequency, GHz	Gain, dBi	Half power beamwidth	XPD dB	F/B ratio, dB	Compliance	
						ETSI	FCC
0.3m	15	32.1	4.3°	30	58	Class 3	N/A
	17	33.4	3.5°	30	60	Class 3	B2
	18	34.2	3.3°	30	61	Class 3	B2
	23	35.3	3.0°	30	62	Class 3	A
	24	36.1	2.6°	30	62	Class 3	N/A
	26	36.6	2.5°	30	63	Class 3	N/A
	38	40.1	1.6°	30	61	Class 3B	A
	42	40.8	1.5°	30	60	Class 3	A
0.6m	15	37.5	2.4°	30	62.5	Class 3	N/A
	17	38.2	2.3°	30	65	Class 3	A
	18	39.1	1.9°	30	64.5	Class 3	A
	23	41.4	1.6°	30	66.5	Class 3	A
	24	41.1	1.4°	30	66	Class 3	N/A
	26	41.6	1.5°	30	68	Class 3	A
	38	45.2	0.9°	30	64	Class 3B	A
	42	46	0.8°	30	65	Class 3	A

Exterior design of Integra-W models

	<p>15-38 GHz</p>	<p>Solution with integrated antenna</p>
	<p>15, 18-23, 26-38 GHz</p>	
	<p>17, 24 GHz</p>	<p>General design</p>
	<p>6-13 GHz</p>	

ABBREVIATIONS

ACI – Adjacent-Channel Interference
ACM – Adaptive Coding and Modulation
ATPC – Automatic Transmit Power Control
BER – Bit-Error Ratio
CCI – Co-Channel Interference
CLI – Command-Line Interface
CPU – Central Processing Unit
CRC – Cyclic Redundancy Check
DC – Direct Current
DiffServ – Differentiated Services
DSCP - Differentiated Services Code Point
ETSI – European Telecommunications Standards Institute
FCC - The Federal Communications Commission
FCS - Frame check sequence
FEC – Forward Error Correction
FO – Fiber Optics
FODU – Full Outdoor Unit
FTP – File Transfer Protocol
GUI – Graphical User Interface
IEEE - Institute of Electrical and Electronics Engineers
IF – Intermediate Frequency
ISP – Internet Service Provider
ITU-T – International Telecommunication Union – Telecommunication Standardization Sector
LAN – Local Area Network
LED – Light-Emitting Diode
MAC – Media Access Control
NMS – Network Management System
PC – Personal Computer
MAC – Media Access Control
NMS – Network Management System
PC – Personal Computer
PLL – Phase-Locked Loop
PoE - Power over Ethernet
QAM - Quadrature amplitude modulation
QoS – Quality of Service
RSL – Received Signal Level
RSS – Radio Standards Specification
RSSI – Received Signal Strength Indicator
Rx – Receive
SNMP - Simple Network Management Protocol
SNR – Signal-to-Noise Ratio
STP – Spanning Tree Protocol
TCP/IP – Internet Protocol Suite (Transmission Control Protocol / Internet Protocol)
TDM – Time-Division Multiplexing
TFTP – Trivial File Transfer Protocol
TM – Tide Mark
TP – Twisted Pair
TS – Threshold Seconds
Tx – Transmit
USB – Universal Serial Bus
VLAN – Virtual Local Area Network
WAN – Wide Area Network



SAF Tehnika JSC

24a, Ganību dambis, Rīga, LV-1005, Latvia, EU

techsupport@saftehnika.com

www.saftehnika.com