



# Vape Detector

Featuring LoRaWAN®

**GS601**

User Guide



## Safety Precautions

Milesight will not hold responsibility for any loss or damage resulting from not following the instructions of this operating guide.

- ❖ The device must not be disassembled or remodeled in any way.
- ❖ To ensure the security of your device, please change the device password during the initial configuration. The default password is 123456.
- ❖ The device is not intended to be used as a reference sensor, and Milesight will not hold responsibility for any damage which may result from inaccurate readings.
- ❖ Do not place the device in places where the temperature is below/above the operating range.
- ❖ Do not place the device near naked flames, heat source (such as oven), or expose it to direct sunlight, cold source, liquid, and with extreme temperature changes.
- ❖ The device must never be subjected to shocks or impacts.

## Declaration of Conformity

GS601 is in conformity with the essential requirements and other relevant provisions of the CE, FCC, and RoHS.

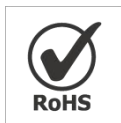

**Copyright © 2011-2024 Milesight. All rights reserved.**

All information in this guide is protected by copyright law. Whereby, no organization or individual shall copy or reproduce the whole or part of this user guide by any means without written authorization from Xiamen Milesight IoT Co., Ltd.

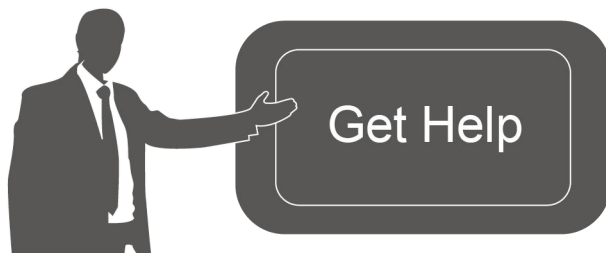

For assistance, please contact

Milesight technical support:

Email: [iot.support@milesight.com](mailto:iot.support@milesight.com)

Support Portal: [support.milesight-iot.com](http://support.milesight-iot.com)

Tel: 86-592-5085280

Fax: 86-592-5023065

Address: Building C09, Software Park  
Phase III, Xiamen 361024,  
China

**Revision History**

Date	Doc Version	Description
Sept.30, 2024	V 1.0	Initial version

# Contents

1. Product Introduction .....	5
1.1 Overview .....	5
1.2 Features .....	5
2. Hardware Introduction .....	5
2.1 Packing List .....	5
2.2 Hardware Overview .....	6
2.4 Button and LED Descriptions .....	6
2.5 Dimensions(mm) .....	7
3. Power Supply .....	7
4. Operation Guide .....	7
4.1 NFC Configuration .....	7
4.2 LoRaWAN® Settings .....	8
4.4.1 Basic Settings .....	8
4.4.2 Multicast Settings .....	11
4.3 General Settings .....	13
4.4 Advanced Settings .....	14
4.4.3 Calibration Settings .....	14
4.4.4 Threshold Settings .....	15
4.5 Maintenance .....	16
4.5.1 Backup .....	16
4.5.2 Upgrade .....	19
4.5.3 Reset .....	19
5. Installation .....	20
6. Device Maintenance .....	21
7. Communication Protocol .....	22
7.1 Basic Information .....	22
7.2 Sensor Data .....	23
7.3 Downlink Commands .....	26
Appendix .....	31
TVOC Levels and Guidelines .....	31

## 1. Product Introduction

### 1.1 Overview

GS601 is a LoRaWAN® vape detector designed to identify vaping and smoking events and send alerts. Equipped with a suite of powerful embedded sensors, GS601 simultaneously measures temperature, humidity, TVOC, and PM parameters.

When environmental changes reach the preset thresholds, the detector activates both the LED light alert and buzzer sound alert.

In addition to local alerts, GS601 can also remotely report the air quality status and alarm messages via LoRaWAN® technology. By integrating with Milesight LoRaWAN® gateway and Milesight Development Platform, users can visually monitor all sensor data and manage the device remotely.

GS601 seamlessly blends into various installation environments, making it ideal for restrooms, changing rooms, classrooms, stairwells, apartments, and other locations.

### 1.2 Features

- Integrated with multiple sensors to detect vape, smoke, TVOC, temperature, humidity, and PM parameters
- Supports anti-water vapor disturbance and other gas interference, with interference information reported
- Equipped with a buzzer and indicator to signal when the device is powered, faulty, alarmed, or in an invalid status
- Supports setting the buzzer hibernate time to avoid false alarms during deployment
- Equipped with a vibration sensor to detect acts of vandalism or tampering
- Supports management and OTA upgrades via Milesight Development Platform
- Built-in NFC for easy configuration
- Compatible with standard LoRaWAN® gateways and network servers

## 2. Hardware Introduction

### 2.1 Packing List



1 × GS601 Sensor

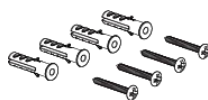

4 × Ceiling Mounting Kits

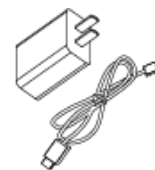

1 × Type-C Cable & Power Adapter



1 × PoE Splitter (Optional)



1 × Warranty Card



1 × Quick Guide

**!** If any of the above items is missing or damaged, please contact your sales representative.

## 2.2 Hardware Overview

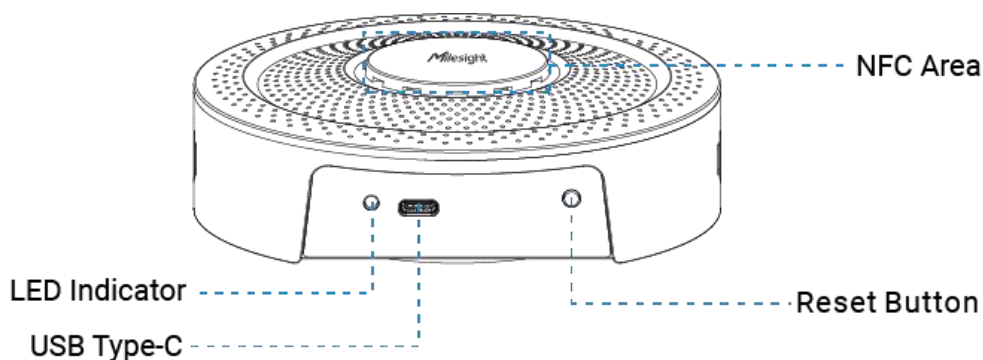

## 2.4 Button and LED Descriptions

Function	Action	LED Indicator
Power On/Off	Connect to the power supply	Static On
	Disconnect power	Light Off
Reboot	Press and hold reset button for over 3s	Blinks Slowly
Reset to Factory	Press and hold reset button for over 10s	Blinks Quickly
Alarm	When one of the measured values exceeds the threshold	Static On
	When someone tampers the device	

## 2.5 Dimensions(mm)

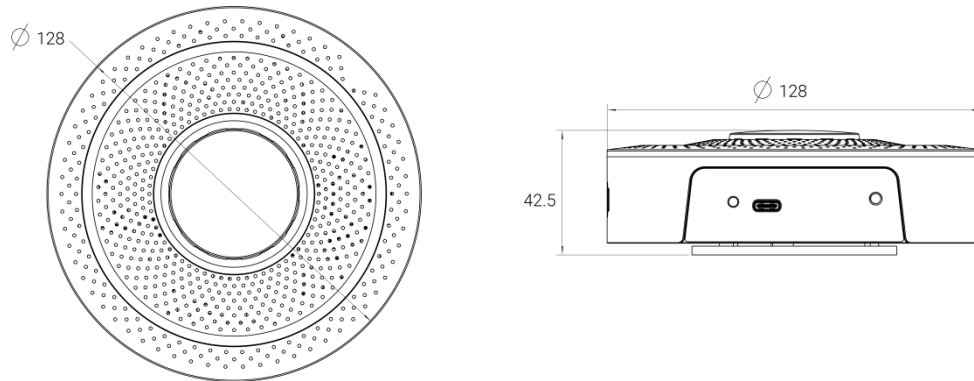

## 3. Power Supply

GS601 can be powered by USB (5V/1A). Choose one of the following methods to power up the device.

- **Powered by a Power Adapter**



- **Powered by a PoE Splitter**

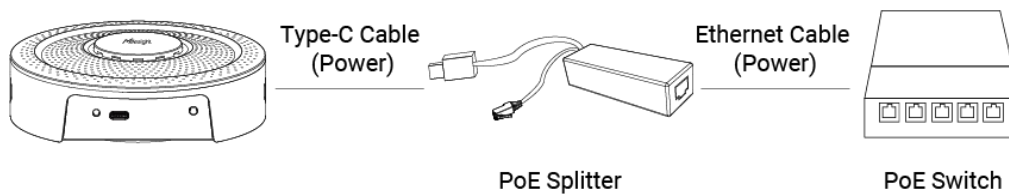

## 4. Operation Guide

### 4.1 NFC Configuration

1. Download and install the Milesight ToolBox App from Google Play or Apple App Store.
2. Enable NFC on your smartphone and launch Milesight ToolBox.
3. Place the smartphone's NFC area near the master device, and click **NFC Read** to read device information. The basic information and settings of the device will be shown on ToolBox App if it's successfully recognized. You can read and configure the device by tapping **Read/Write** on the App. For better security, please change the password during the first configuration. The default password is **123456**.

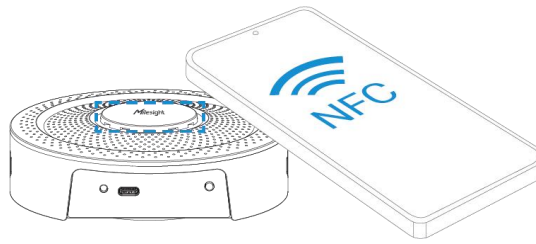
**Note:**

- 1) Locate the NFC detection area on the smartphone and it is recommended to remove your phone case.
- 2) If the smartphone fails to read/write configurations via NFC, detach the phone from the device and try again.

## 4.2 LoRaWAN® Settings

### 4.4.1 Basic Settings

Configure AppEUI, Join Type, Application Key, and other information. You can also keep all the default settings.

Device EUI

24E124850E233488

APP EUI

24e124c0002a0001

\* Application Port

85

LoRaWAN Version

V1.0.3

Work Mode

Class C

Parameters	Description
Device EUI	Unique ID of the device which can also be found on the label.
App EUI	The default App EUI is 24E124C0002A0001.
Application Port	The port is used for sending and receiving data, the default port is 85.
LoRaWAN® Version	V1.0.2 and V1.0.3 are available.



Work Mode	It is fixed as Class C.												
Confirmed Mode	If the device does not receive an ACK packet from the network server, it will resend data once.												
Join Type	Both OTAA and ABP modes are available.												
Application Key	Appkey for OTAA mode, the default is 5572404C696E6B4C6F52613230313823.												
Network Session Key	Nwkskey for ABP mode, the default is 5572404C696E6B4C6F52613230313823.												
Application Session Key	Appskey for ABP mode, the default is 5572404C696E6B4C6F52613230313823.												
Device Address	DevAddr for ABP mode, the default is the 5th to 12th digits of the SN.												
Supported Frequency	<p>Enable or disable the frequency to send uplinks.</p> <p>* Support Frequency</p> <p>EU868</p> <p>Frequency/MHz</p> <table border="1"> <tr> <td>868.1</td> <td><input checked="" type="checkbox"/></td> </tr> <tr> <td>868.3</td> <td><input checked="" type="checkbox"/></td> </tr> <tr> <td>868.5</td> <td><input checked="" type="checkbox"/></td> </tr> <tr> <td>867.1</td> <td><input type="checkbox"/></td> </tr> <tr> <td>867.3</td> <td><input type="checkbox"/></td> </tr> <tr> <td>...</td> <td><input type="checkbox"/></td> </tr> </table> <p>If frequency is one of AU915/US915, enter the index of the channel that you want to enable and make them separated by commas.</p> <p><b>Examples:</b></p> <p>1, 40: Enabling Channel 1 and Channel 40</p> <p>1-40: Enabling Channel 1 to Channel 40</p> <p>1-40, 60: Enabling Channel 1 to Channel 40 and Channel 60</p> <p>All: Enabling all channels</p> <p>Null: Indicate that all channels are disabled</p>	868.1	<input checked="" type="checkbox"/>	868.3	<input checked="" type="checkbox"/>	868.5	<input checked="" type="checkbox"/>	867.1	<input type="checkbox"/>	867.3	<input type="checkbox"/>	...	<input type="checkbox"/>
868.1	<input checked="" type="checkbox"/>												
868.3	<input checked="" type="checkbox"/>												
868.5	<input checked="" type="checkbox"/>												
867.1	<input type="checkbox"/>												
867.3	<input type="checkbox"/>												
...	<input type="checkbox"/>												

	<p>* Support Frequency</p> <p>US915</p> <p>Enable Channel Index ⓘ</p> <p>0-71</p> <table border="1"> <thead> <tr> <th>Index</th> <th>Frequency/MHz ⓘ</th> </tr> </thead> <tbody> <tr> <td>0 - 15</td> <td>902.3 - 905.3</td> </tr> <tr> <td>16 - 31</td> <td>905.5 - 908.5</td> </tr> <tr> <td>32 - 47</td> <td>908.7 - 911.7</td> </tr> <tr> <td>48 - 63</td> <td>911.9 - 914.9</td> </tr> <tr> <td>64 - 71</td> <td>903 - 914.2</td> </tr> </tbody> </table>	Index	Frequency/MHz ⓘ	0 - 15	902.3 - 905.3	16 - 31	905.5 - 908.5	32 - 47	908.7 - 911.7	48 - 63	911.9 - 914.9	64 - 71	903 - 914.2
Index	Frequency/MHz ⓘ												
0 - 15	902.3 - 905.3												
16 - 31	905.5 - 908.5												
32 - 47	908.7 - 911.7												
48 - 63	911.9 - 914.9												
64 - 71	903 - 914.2												
Rejoin Mode	<p>Reporting interval <math>\leq</math> 35 mins: the device will send a specific number of LinkCheckReq MAC packets to the network server every reporting interval or every double reporting interval to validate connectivity; If there is no response, the device will rejoin the network.</p> <p>Reporting interval <math>&gt;</math> 35 mins: the device will send a specific number of LinkCheckReq MAC packets to the network server every reporting interval to validate connectivity; If there is no response, the device will rejoin the network.</p> <p><b>Note:</b> Only OTAA mode supports rejoin mode.</p>												
Set the number of packets sent	<p>When the rejoin mode is enabled, set the number of LinkCheckReq packets to send.</p> <p><b>Note:</b> the actual sending number is <b>Set the number of packet sent + 1</b>.</p>												
ADR Mode	Allow network server to adjust the data rate of the device.												
Spreading Factor	If ADR is disabled, the device will send data via this spread factor.												
Tx Power	Transmit power of the device.												
RX2 Data Rate	RX2 data rate to receive downlinks.												
RX2 Frequency	RX2 frequency to receive downlinks. Unit: Hz												

**Note:**

- 1) Please contact sales personnel for device EUI list if there are many units.
- 2) Please contact sales personnel if you need random App keys before purchase.
- 3) Select OTAA mode if you are using Milesight Development Platform to manage devices.

#### 4.4.2 Multicast Settings

Milesight gateways supports setting up several multicast groups to receive multicast commands from network servers and users can use this feature to control devices in bulks.

1. Enable **Multicast Group** and set a unique multicast address and keys to distinguish other groups. You can also keep these settings by default.

Multicast Group1

Multicast Address ⓘ

McNetSKey

McAppSKey

Multicast Group2

Multicast Group3

Parameters	Description
Multicast Address	Unique 8-digit address to distinguish different multicast groups.
Multicast McNetSkey	32-digit key. Default values: Multicast Group 1: 5572404C696E6B4C6F52613230313823 Multicast Group 2: 5572404C696E6B4C6F52613230313824 Multicast Group 3: 5572404C696E6B4C6F52613230313825 Multicast Group 4: 5572404C696E6B4C6F52613230313826
Multicast McAppSkey	32-digit key. Default values: Multicast Group 1: 5572404C696E6B4C6F52613230313823 Multicast Group 2: 5572404C696E6B4C6F52613230313824 Multicast Group 3: 5572404C696E6B4C6F52613230313825 Multicast Group 4: 5572404C696E6B4C6F52613230313826

2. Add a multicast group on the network server. Take Milesight UG6x gateway as an example, go to **Network Server > Multicast Groups**, and click **Add** to add a multicast group.

Multicast Address	Group Name	Number of Devices	Operation
No matching records found			

Fill in the multicast group information that is the same as device settings, and select the devices that you need to control, then click **Save**.

Group Name: vape detector

Multicast Address: 11111111

Multicast Network Session Key: 5572404c696e6b4c6f52613230

Multicast Application Session Key: 5572404c696e6b4c6f52613230

Class Type: Class C

Datarate: DR0 (SF12, 125kHz)

Frequency: 869525000 Hz

Frame-counter: 1

Selected Devices: GS601

Add Device

Save

Multicast Address	Group Name	Number of Devices	Operation
11111111	vape detector	1	

Showing 1 to 1 of 1 rows

3. Go to **Network Server > Packets**, select the multicast group and fill in the downlink command, then click **Send**. The network server will broadcast the command to devices that belong to this multicast group.

**Note:** Ensure all devices' application ports are the same.

General Applications Payload Codec Profiles Device Multicast Groups Gateway Fleet **Packets**

**Send Data To Device**

Device EUI	Type	Payload	Port	Confirmed	Send
0000000000000000	ASCII		85	<input type="checkbox"/>	Send

**Send Data to Multicast Group**

Multicast Group	Type	Payload	Port	Send
vape detector	hex	bd	85	Send

### 4.3 General Settings

Device Network

General Calibration Th ...

Reporting Interval(min)

3

Temperature Unit

°C

LED Indicator

Buzzer

Tampering Alarms ⓘ

Time Zone

UTC+8 (CT/CST: China St...)

Parameters	Description
Reporting Interval	Reporting interval of transmitting data to the server. Default: 10 min, Range: 1 - 1440 min.
Temperature Unit	Choose °C or °F to display in ToolBox App.
LED Indicator	Enable or disable the LED Indicator to display alarm status.
Buzzer	Enable or disable the buzzer to sound for three reasons: the vaping index exceeds the threshold, triggering the tamper alarm and triggering the burning alarm. <b>Hibernate Period:</b> When enabled, the buzzer will not respond when the

	<p>vaping index exceeds the threshold within the set time period.</p> <p><b>Stop Buzzer:</b> When enabled, press the reset button to turn off the current buzzer alarm.</p>
Tampering Alarms	<p>After enabled, if the device is tampered with or forcibly moved, it will trigger an alarm accompanied by a red light and a buzzer.</p>
Time Zone	<p>Set the time zone of the current location. When you click <b>Sync</b> button of ToolBox App to sync time, the device will also sync the time zone from smartphone automatically.</p>
Daylight Saving Time	<p>Enable or disable Daylight Saving Time (DST).</p> <p><b>Start Time:</b> the start time of DST time range.</p> <p><b>End Time:</b> the end time of DST time range.</p> <p><b>DST Bias:</b> the DST time will be faster according to this bias setting.</p>
Change Password	<p>Change the password for ToolBox App to write to this device.</p>

## 4.4 Advanced Settings

### 4.4.3 Calibration Settings

Go to **Device > Setting > Calibration** to enable calibration.

General **Calibration** Thi ...

Temperature

Current Value(°C) **29.2** Final Value(°C) **28.7**

Calibration Value(°C)  
-0.5

Humidity

Vaping Index

PM1.0

PM2.5

PM10

TVOC

#### 4.4.4 Threshold Settings

Go to **Device > Setting > Threshold** of ToolBox App to enable and configure the threshold settings. If the threshold is triggered, the device will report the threshold alarm packets instantly.

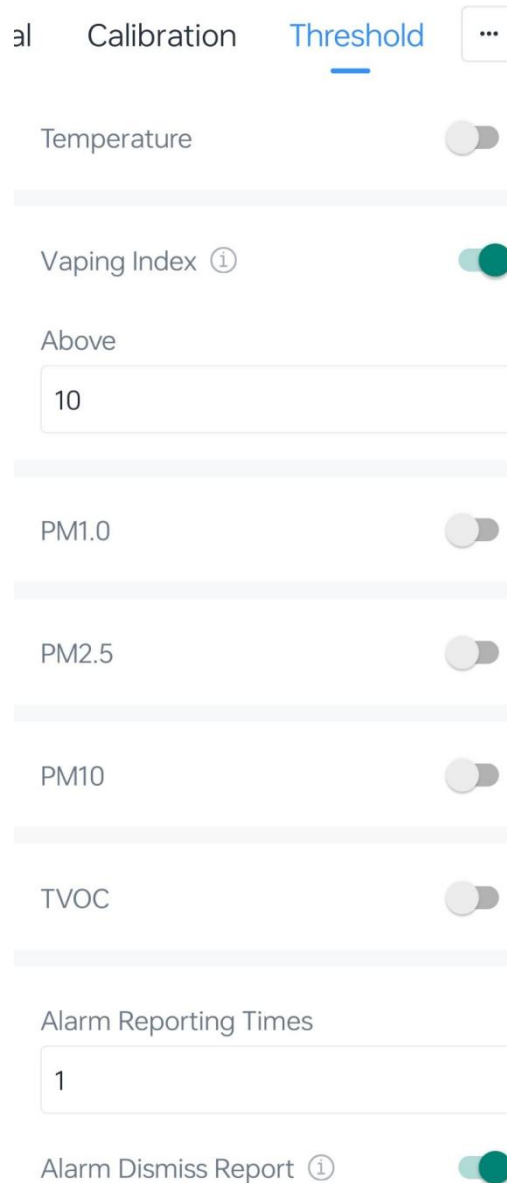

Parameters	Description
Alarm Reporting Times	Set the number of alarm reports to be sent after the threshold is triggered, the default value is 1.
Alarm Dismiss Report	Once enabled, the device will send an alarm dismiss report when it detects a value below the threshold for 1 minute (vape index) or if the collected value is below the threshold for 3 continuous times (for other items except the vape index).

## 4.5 Maintenance

### 4.5.1 Backup

GS601 supports backup templates for quick and easy device configurations in bulk. The backup feature is only available for devices with the same model and LoRaWAN® frequency band.



1. Click  to go to **Template** page in the App, click **Add Template** to save the current settings as a template. The saved templates are also editable.

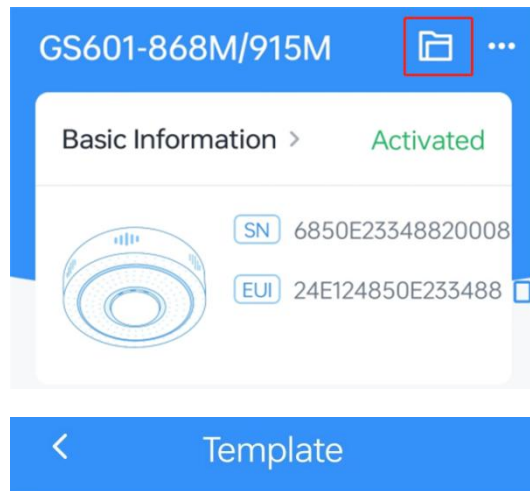

You haven't saved the template yet



2. Select one saved template and click **Write**, then attach the smartphone to another device via NFC to import the template.

Temperature Unit

°C

LED Indicator

Buzzer

Tampering Alarms ⓘ

Time Zone

UTC (WET: Western Euro...)

Write

**Note:** Check the box to export or delete the template. Click the template to edit the configurations.

< Template Import

🔍 Enter keywords

2024/09

GS601-868M/915M\_20240913  
Last Modified Time: 2024-09-13 15:34:21

↓  
Export

🗑️  
Delete

### 4.5.2 Upgrade

1. Download firmware from the Milesight website to your smartphone.
2. Go to **Maintenance** page of ToolBox App, and tap **Upgrade** to import firmware and upgrade the device.

**Note:** Operation on ToolBox is not supported during the upgrade.

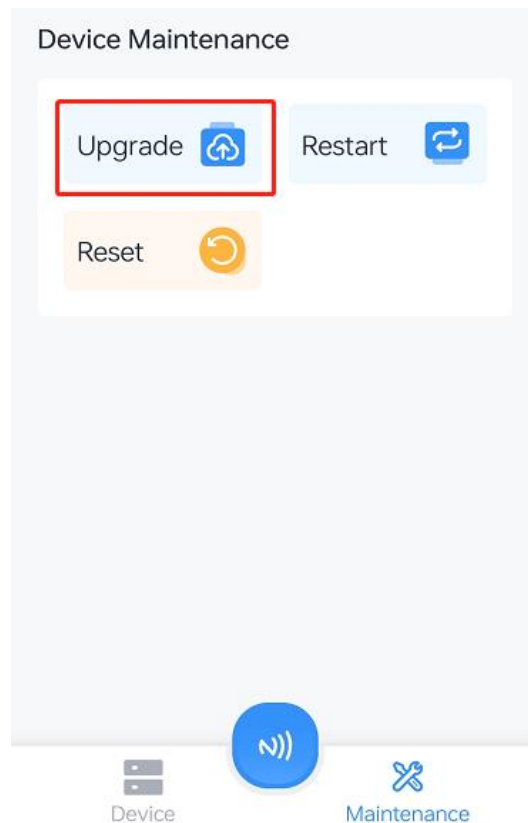

### 4.5.3 Reset

GS601 supports two methods to reset the device, which are as follows:

**Via Hardware:** Press and hold on the device's reset button for 10s .

**Via ToolBox App:** Go to **Maintenance** page to tap **Reset**, then attach the smartphone to the device via NFC to complete the reset.

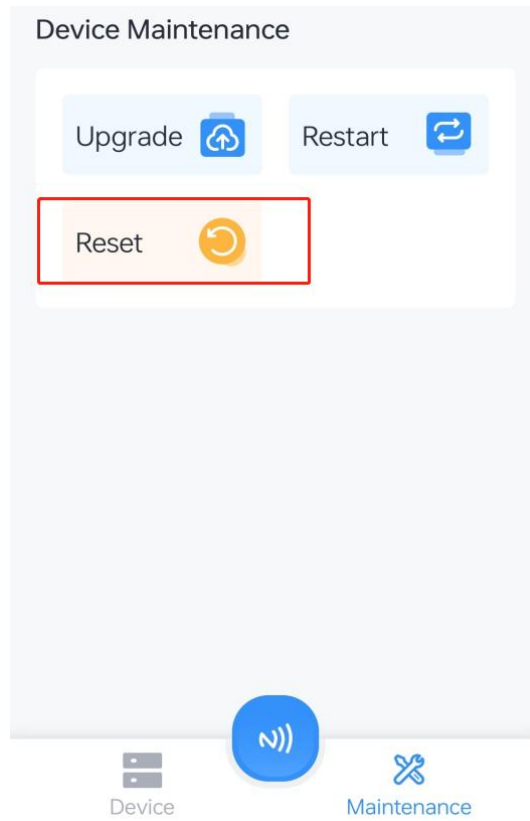

## 5. Installation

### Installation Location:

- Recommended installation height and environment: On the ceiling at a height of 2.4m to 3m in areas where smoking may occur.
- Avoid installing the device near large metal objects and in areas where it may be exposed to liquid sprays.
- The device's response speed is affected by the ambient airflow. It is recommended to install it in places where the airflow is stable, such as 30-70cm away from exhaust fans. Avoid installing it in places with unstable airflow, such as near doors/windows/air conditioning vents/places directly blown by fans. Ensure a distance of more than 30cm, and the greater the wind force, the farther the distance should be.

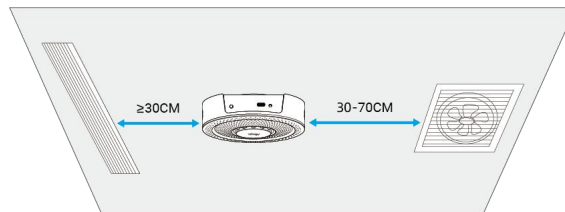

- If there are no exhaust fans or other ventilation equipment in the installation environment, it is recommended to deploy devices within a detection range of a 1.5m radius.
- In an installation environment with partitions or dividers (like toilet): If the partitions or

dividers extend to the ceiling, it is recommended to install one device in each partition or divider; If not, it is recommended to deploy devices according to the detection range of a 1.5m radius.

### Installation Steps:

**Step 1:** Hold the back mounting plate, rotate counterclockwise to remove the mounting plate from the back of the device.

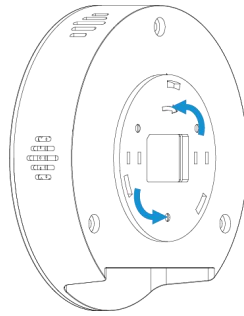

**Step 2:** Drill 3 holes in the ceiling according to the mounting plate. Insert the wall plugs into the holes, then secure the mounting plate with screws.

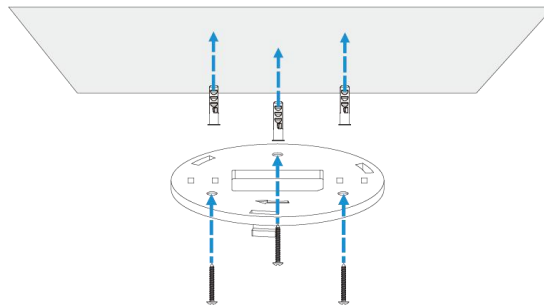

**Step 3:** Align the three holes on the device with the three protrusions on the mounting bracket, then rotate the device clockwise to secure it.

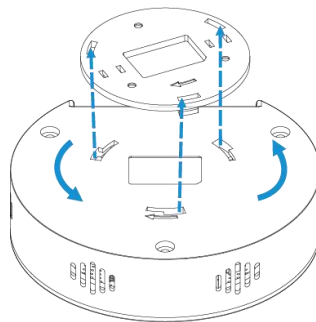

## 6. Device Maintenance

- Avoid exposing the device to gases with high concentrations over a long period time, or it may damage the device and decrease the performance.

- Do not expose the device to corrosive gas, silicon vapor or high levels of volatile organic compounds.
- Do not clean the device with detergents or solvents such as benzene or alcohol. To clean the device, wipe with a soft moistened cloth. Use another soft, dry cloth to wipe dry.
- Do not paint or cover the device, which may block the air inlets.
- It is suggested to place device under well-ventilated environment, otherwise the accuracy of TVOC will drop.
- There may be an accuracy drift in TVOC detection if the device is stored without power for a long time, and different devices may experience varying degrees of TVOC drift. If you prefer a more consistent reading with better precision, you can keep the device powered on in clear air for some time according to the below list.

Storage Time (Power Off)	Operating Time
Less than 1 month	At least 2 days
1~6 months	At least 3 days
More than 6 months	At least 7 days

## 7. Communication Protocol

All data are based on following format (HEX), the Data field should follow little-endian:

Channel1	Data1	Channel2	Data2	...
1 Byte	N Bytes	1 Byte	M Bytes	...

For decoder examples please find files on <https://github.com/Milesight-IoT/SensorDecoders>.

### 7.1 Basic Information

GS601 reports basic information of the device whenever joining the network.

Item	Channel	Byte	Value
Protocol version	df	2	0102: V1.2
Reset Report	ee	0	Reset
Device SN	db	8	16 digits
Device Version	da	8	Hardware Version (2B) + Software Version: 010101(2B) + 00000000
OEM ID	d9	2	4 digits
Power On	c8	1	01: Device is on
Device Type	cf00	1	02: Class C

**Example:**

df0100 ee db6850e23348820008 da0100010100000000 d91234 c801 cf0002	
Channel	Value
df (Protocol version)	0102: V1.2
ee (Reset Report)	Reset
db (Device SN)	6850e23348820008
da (Device Version)	Hardware Version: 0100(V1.0) Software Version: 0101(V1.1)
d9 (OEM ID)	1234
c8 (Power On)	01: Device is on
cf00 (Device Type)	02: Class C

## 7.2 Sensor Data

Item	Channel	Byte	Description
Vaping Index	01	1	UINT8, Range: 0~100
Vaping Index Alarm	02	1/2	<ul style="list-style-type: none"> <li>Byte1:           <ul style="list-style-type: none"> <li>00-Collecting failed;</li> <li>01-Under-range;</li> <li>02-Over-range;</li> <li>10-Threshold Alarm Dismiss;</li> <li>11-Threshold Alarm;</li> <li>20-Water Vapor Interference Alarm Dismiss;</li> <li>21-Water Vapor Interference Alarm</li> </ul> </li> <li>Byte2: UINT8, Range: 0~100</li> </ul>
PM1.0	03	2	UINT16, Unit: $\mu\text{g}/\text{m}^3$ , Range: 0~1000
PM1.0 Alarm	04	1/3	<ul style="list-style-type: none"> <li>Byte1:           <ul style="list-style-type: none"> <li>00-Collecting failed;</li> <li>01-Under-range;</li> <li>02-Over-range;</li> <li>10-Threshold Alarm Dismiss;</li> <li>11-Threshold Alarm;</li> </ul> </li> <li>Byte2-3: UINT16, Unit: <math>\mu\text{g}/\text{m}^3</math>, Range: 0~1000</li> </ul>
PM2.5	05	2	UINT16, Unit: $\mu\text{g}/\text{m}^3$ , Range: 0~1000
PM2.5 Alarm	06	1/3	<ul style="list-style-type: none"> <li>Byte1:</li> </ul>

			<ul style="list-style-type: none"> <li>00-Collecting failed;</li> <li>01-Under-range;</li> <li>02-Over-range;</li> <li>10-Threshold Alarm Dismiss;</li> <li>11-Threshold Alarm;</li> <li>● Byte2-3: UINT16, Unit: <math>\mu\text{g}/\text{m}^3</math>, Range: 0~1000</li> </ul>
PM10	07	2	UINT16, Unit: $\mu\text{g}/\text{m}^3$ , Range: 0~1000
PM10 Alarm	08	1/3	<ul style="list-style-type: none"> <li>● Byte1: <ul style="list-style-type: none"> <li>00-Collecting failed;</li> <li>01-Under-range;</li> <li>02-Over-range;</li> <li>10-Threshold Alarm Dismiss;</li> <li>11-Threshold Alarm;</li> </ul> </li> <li>● Byte2-3: UINT16, Unit: <math>\mu\text{g}/\text{m}^3</math>, Range: 0~1000</li> </ul>
Temperature	09	2	INT16*0.1, Unit: $^{\circ}\text{C}$ , Range: -20~60
Temperature Alarm	0a	1/3	<ul style="list-style-type: none"> <li>● Byte1: <ul style="list-style-type: none"> <li>00-Collecting failed;</li> <li>01-Under-range;</li> <li>02-Over-range;</li> <li>10-Threshold Alarm Dismiss;</li> <li>11-Threshold Alarm;</li> <li>20-Burning Alarm Dismiss;</li> <li>21-Burning Alarm (Temperature &gt; 70<math>^{\circ}\text{C}</math> or change of temperature &gt; 15 <math>^{\circ}\text{C}</math> within 15s)</li> </ul> </li> <li>● Byte2-3: INT16*0.1, Unit: <math>^{\circ}\text{C}</math>, Range: -20~60</li> </ul>
Humidity	0b	2	UINT16*0.1, Unit: %, Range: 0~100
Humidity Alarm	0c	1	<ul style="list-style-type: none"> <li>00-Collecting failed;</li> <li>01-Under-range;</li> <li>02-Over-range</li> </ul>
TVOC	0d	2	UINT16, Unit: $\mu\text{g}/\text{m}^3$ , Range: 0~2000



TVOC Alarm	0e	1/3	<ul style="list-style-type: none"> <li>Byte1:                     <ul style="list-style-type: none"> <li>00-Collecting failed;</li> <li>01-Under-range;</li> <li>02-Over-range;</li> <li>10-Threshold Alarm Dismiss;</li> <li>11-Threshold Alarm;</li> </ul> </li> <li>Byte2-3: UINT16, Unit: <math>\mu\text{g}/\text{m}^3</math>, Range: 0~2000</li> </ul>
Tampering Status	0f	1	01-Triggered; 00-Normal
Tampering Alarm	10	1	21-Alarm; 20-Alarm Dismiss
Buzzer	11	1	00-buzzer is not beeping 01-buzzer is beeping

**Example:**

## 1. Periodic Package

0104 030f00 051000 071100 091c01 0b0702 0d0000 0f00 1100			
Channel	Value	Channel	Value
01 (Vaping Index)	04 => 4	03 (PM1.0)	0f 00 => 000f =>15 $\mu\text{g}/\text{m}^3$
Channel	Value	Channel	Value
05 (PM2.5)	1000 => 0010=16 $\mu\text{g}/\text{m}^3$	07 (PM10)	1100 => 0011=17 $\mu\text{g}/\text{m}^3$
Channel	Value	Channel	Value
09 (Temperature)	1c01 => 011c=284*0.1=28.4°C	0b (Humidity)	0702 => 0207 =>519*0.1 =51.9%
Channel	Value	Channel	Value
0d (TVOC)	0000 => 0 $\mu\text{g}/\text{m}^3$	0f (Tampering Status)	00 => Normal
Channel	Value		
11 (Buzzer)	00 => No beep		

## 2. Report Alarm: the environment detection item exceeds threshold.

0a112001 1100			
Channel	Value	Channel	Value
0a (Temperature Alarm)	11=>Threshold Alarm 2001 => 0120=288*0.1=28.8°C	11 (Buzzer)	00 => No beep

## 3. Report Alarm: Tampering Alarm.

1021 1101			
-----------	--	--	--

Channel	Value	Channel	Value
0a (Tampering Alarm)	11=> Alarm	11 (Buzzer)	01 => Beep

### 7.3 Downlink Commands

GS601 supports downlink commands to configure the device. The application port is 85 by default.

#### Configure Command:

Item	Channel	Byte	Description
Reporting Interval	60	3	<ul style="list-style-type: none"> <li>Byte1:Unit 00-Second; 01-Minute</li> <li>Byte2-3: Interval, UINT16, Range: 10~64800s or 1~1440min</li> </ul>
Temperature Unit	61	1	00-°C; 01-°F
LED Indicator	62	1	01-Enable; 00-Disable
Buzzer	63	1	01-Enable; 00-Disable
Buzzer Hibernate Period	64	6	<ul style="list-style-type: none"> <li>Byte1: 01-Period 1; 02-Period 2</li> <li>Byte2: 01-Enable; 00-Disable</li> <li>Byte3-4: Start Time, UINT16, Unit: min, Range: 0~1440</li> <li>Byte5-6: End Time, UINT16, Unit: min, Range: 0~1440</li> </ul>
Stop Buzzer	67	1	01-Enable; 00-Disable
Mute Buzzer Time	66	2	UINT16, Unit: min, Range: 1~1440 This downlink is only set for the tamper alarm.
Tampering Alarm	67	1	01-Enable; 00-Disable
UTC Time Zone	c7	2	INT16 / 60
Daylight Saving Time	c6	10	<ul style="list-style-type: none"> <li>Byte1: 01-Enable; 00-Disable</li> <li>Byte2: DST Bias, INT8,</li> </ul>

			<p>Unit:min</p> <ul style="list-style-type: none"> <li>● Byte3: Start Month</li> <li>● Byte4: <ul style="list-style-type: none"> <li>➢ Bit 7-4: Start Week</li> <li>➢ Bit 3-0: Start Day</li> </ul> </li> <li>● Byte5-6: Start Time, UINT 16, Unit:min</li> <li>● Byte7: End Month</li> <li>● Byte8: <ul style="list-style-type: none"> <li>➢ Bit 7-4:End Week</li> <li>➢ Bit 3-0: End Day</li> </ul> </li> <li>● Byte9-10: End Time, UINT 16, Unit:min</li> </ul>
Temperature Calibration	71	3	<ul style="list-style-type: none"> <li>● Byte1: 01-Enable; 00-Disable</li> <li>● Byte2-3: INT16*0.1, Unit: °C, Range: -80~80</li> </ul>
Humidity Calibration	72	3	<ul style="list-style-type: none"> <li>● Byte1: 01-Enable; 00-Disable</li> <li>● Byte2-3: INT16*0.1, Unit: %, Range: -100~100</li> </ul>
Vaping Index Calibration	77	2	<ul style="list-style-type: none"> <li>● Byte1: 01-Enable; 00-Disable</li> <li>● Byte2: INT8, Range: -100~100</li> </ul>
PM1.0 Calibration	73	3	<ul style="list-style-type: none"> <li>● Byte1: 01-Enable; 00-Disable</li> <li>● Byte2-3: INT16, Unit: <math>\mu\text{g}/\text{m}^3</math>, Range: -1000~1000</li> </ul>
PM2.5 Calibration	74	3	<ul style="list-style-type: none"> <li>● Byte1: 01-Enable; 00-Disable</li> <li>● Byte2-3: INT16, Unit: <math>\mu\text{g}/\text{m}^3</math>, Range: -1000~1000</li> </ul>
PM10 Calibration	75	3	<ul style="list-style-type: none"> <li>● Byte1:</li> </ul>

			<p>01-Enable; 00-Disable</p> <ul style="list-style-type: none"> <li>● Byte2-3: INT16, Unit: <math>\mu\text{g}/\text{m}^3</math>, Range: -1000~1000</li> </ul>
TVOC Calibration	76	3	<ul style="list-style-type: none"> <li>● Byte1: 01-Enable; 00-Disable</li> <li>● Byte2-3: INT16, Unit: <math>\mu\text{g}/\text{m}^3</math>, Range: -2000~2000</li> </ul>
Temperature Threshold	69	6	<ul style="list-style-type: none"> <li>● Byte1: 01-Enable; 00-Disable</li> <li>● Byte2: 00-disable; 01-below; 02-over; 03-within; 04-below or over</li> <li>● Byte3-4: Min. Value, INT16*0.1, Unit: <math>^{\circ}\text{C}</math></li> <li>● Byte5-6: Max. Value, INT16*0.1, Unit: <math>^{\circ}\text{C}</math></li> </ul>
Vaping Index Threshold	6e	4	<ul style="list-style-type: none"> <li>● Byte1: 01-Enable; 00-Disable</li> <li>● Byte2: 00-disable; 01-below; 02-over; 03-within; 04-below or over</li> <li>● Byte3: Min. Value, UINT8</li> <li>● Byte4: Max. Value, UINT8</li> </ul>
PM1.0 Threshold	6a	6	<ul style="list-style-type: none"> <li>● Byte1: 01-Enable; 00-Disable</li> <li>● Byte2: 00-disable; 01-below; 02-over; 03-within; 04-below or over</li> <li>● Byte3-4: Min. Value, INT16*0.1, Unit: <math>\mu\text{g}/\text{m}^3</math></li> <li>● Byte5-6: Max. Value, INT16*0.1, Unit: <math>\mu\text{g}/\text{m}^3</math></li> </ul>
PM2.5 Threshold	6b	6	<ul style="list-style-type: none"> <li>● Byte1: 01-Enable; 00-Disable</li> </ul>

			<ul style="list-style-type: none"> <li>● Byte2: 00-disable; 01-below; 02-over; 03-within; 04-below or over</li> <li>● Byte3-4: Min. Value, INT16*0.1, Unit: <math>\mu\text{g}/\text{m}^3</math></li> <li>● Byte5-6: Max. Value, INT16*0.1, Unit: <math>\mu\text{g}/\text{m}^3</math></li> </ul>
PM10 Threshold	6c	6	<ul style="list-style-type: none"> <li>● Byte1: 01-Enable; 00-Disable</li> <li>● Byte2: 00-disable; 01-below; 02-over; 03-within; 04-below or over</li> <li>● Byte3-4: Min. Value, INT16*0.1, Unit: <math>\mu\text{g}/\text{m}^3</math></li> <li>● Byte5-6: Max. Value, INT16*0.1, Unit: <math>\mu\text{g}/\text{m}^3</math></li> </ul>
TVOC Threshold	6d	6	<ul style="list-style-type: none"> <li>● Byte1: 01-Enable; 00-Disable</li> <li>● Byte2: 00-disable; 01-below; 02-over; 03-within; 04-below or over</li> <li>● Byte3-4: Min. Value, INT16, Unit: <math>\mu\text{g}/\text{m}^3</math></li> <li>● Byte5-6: Max. Value, INT16, Unit: <math>\mu\text{g}/\text{m}^3</math></li> </ul>
Alarm Reporting Times	6f	2	UINT16, Range: 1~1000
Alarm Dismiss Report	70	1	01-Enable; 00-Disable

**Control Command:**

Item	Channel
Reboot	be
Query Periodic Report	b9
Stop Buzzer Alarm	5f
Rejoin the Network	0b

**Example:**

1. Set reporting interval as 20 minutes.

60 01 1400	
Channel	Value
60	01=Minute 14 00 => 00 14 = 20 minutes

2. Set Vaping Index threshold as above 2.

6e 01020002	
Channel	Value
6e	01=>Enable 02=>over 00=>Min. Value 02=>Max. Value

3. Set time zone to UTC-4 for time display on ToolBox App.

c7 10ff	
Channel	Value
c7	10 ff => ff10 = -240/60 = -4

4. Set Daylight Saving Time from Mar. /2nd /Sun. 14:00 to Nov. /1st /Mon 14:00 and Bias as 60min.

c6 01 3c 03 27 4803 0b 11 4803	
Channel	Value
c6	01=enable Bias: 3c=60min Start Month: 03=March 27=>0010 0111 Start Week: 0010=2= 2 <sup>nd</sup> Start Day: 0111=7=Sunday Start Time: 48 03=> 03 48=>840min=14:00 End Month: 0b=11=Nov. 11=>0001 0001 End Week: 0001=1=1 <sup>st</sup> End Day: 0001=1=Monday End Time: 48 03=> 03 48=>840min=14:00

5. Mute the Buzzer for 10 minute.

66 0a00	
Channel	Value

66	0a 00 => 00 0a = 10 min
----	-------------------------

6. Reboot.

be
----

## Appendix

### TVOC Levels and Guidelines

IAQ Rating	TVOC ( $\mu\text{g}/\text{m}^3$ )	Air Quality
$\leq 1.99$	<300	Very Good
2.00 to 2.99	300 to 1000	Good
3.00 to 3.99	1000 to 3000	Medium (not recommended for exposure > 12 months)
4.00 to 4.99	3000 to 10000	Poor (not recommended for exposure > 1 month)
$\geq 5.00$	>10000	Bad (not recommended)

**Note:** The conversion from  $\mu\text{g}/\text{m}^3$  to ppb by the factor is approximately 0.5.

**-END-**