

1

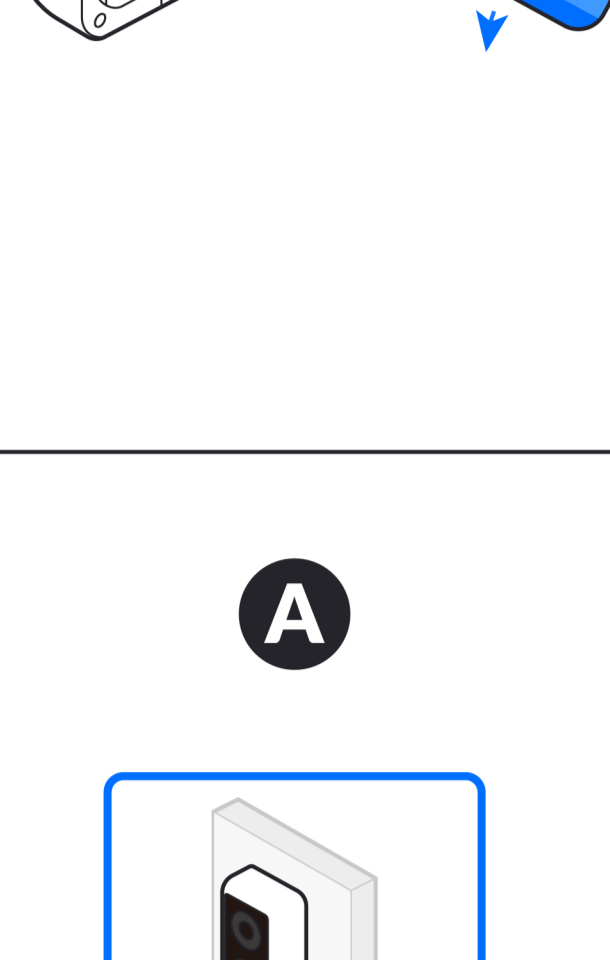

2

A

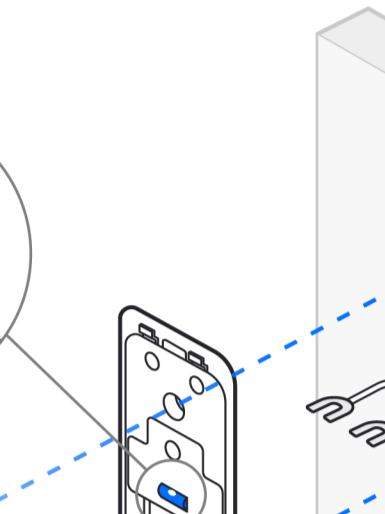

- 1 Pencil
- 2 Power drill
- 3 $\text{\O}6\text{mm}$ ($\text{\O}1/4''$) drill bit
- 4 Hammer
- 5 Screwdriver

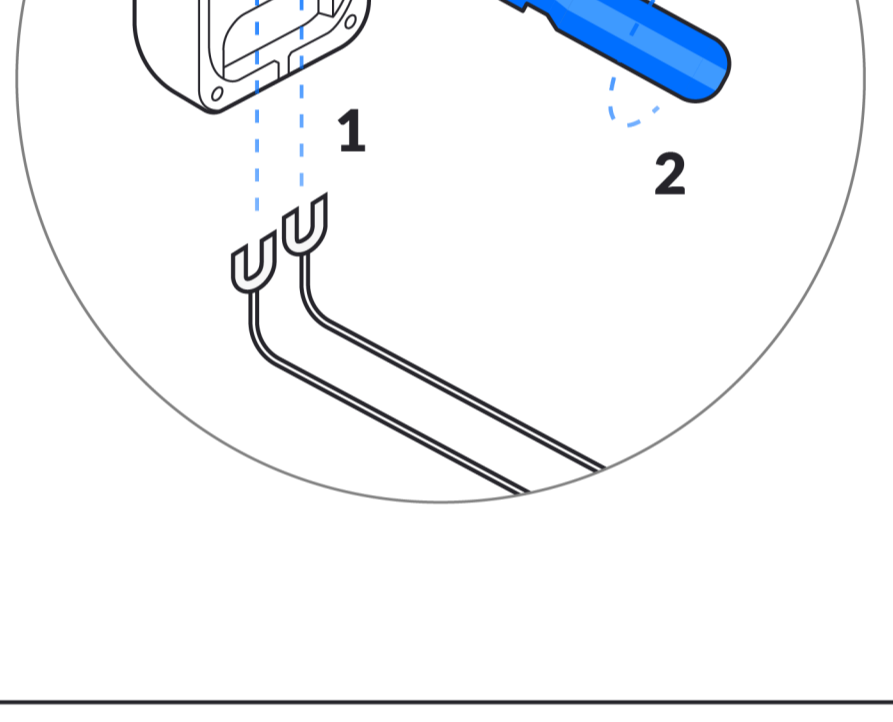
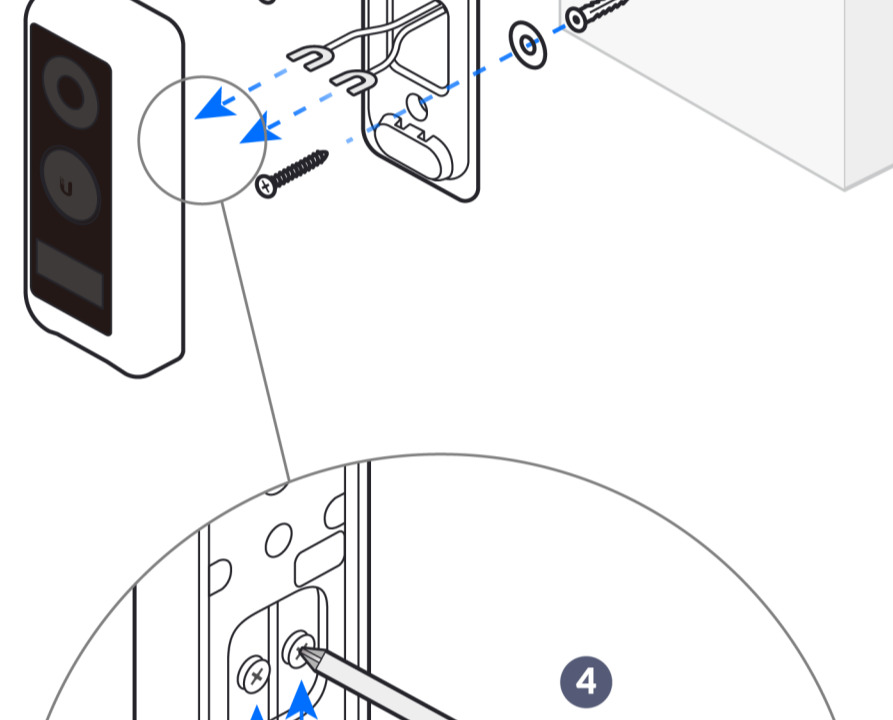
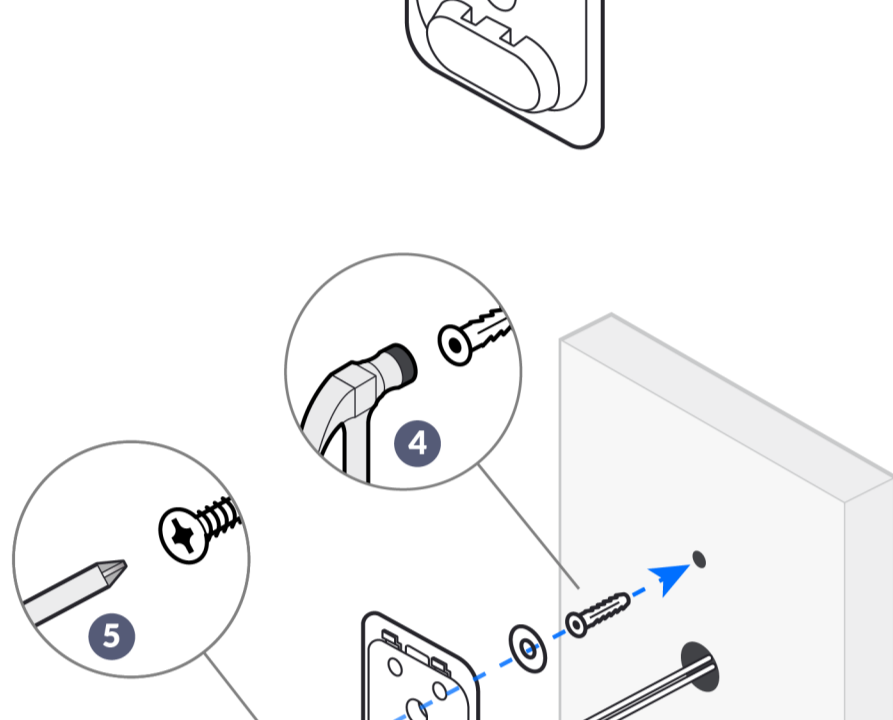
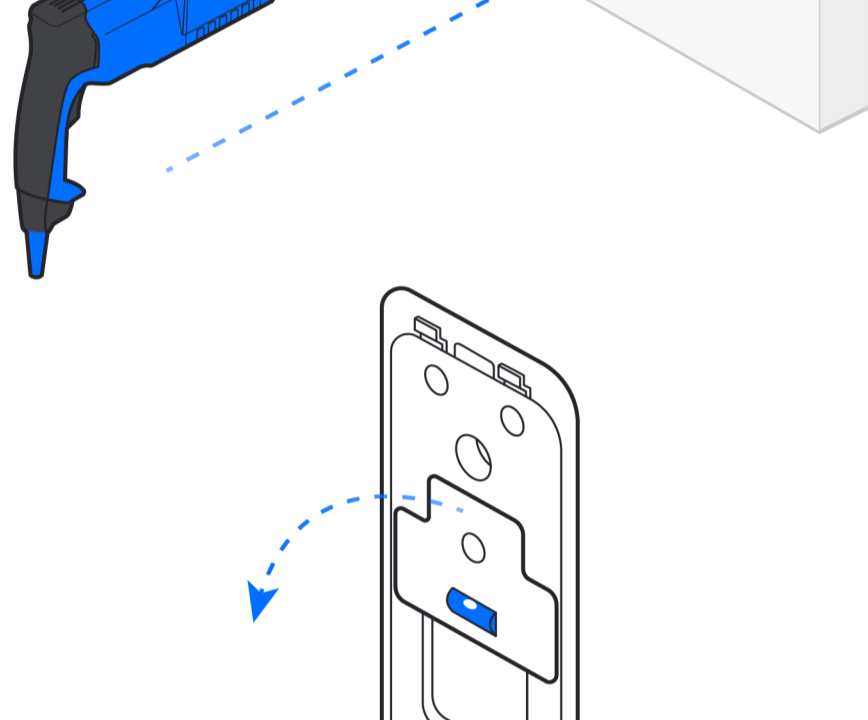
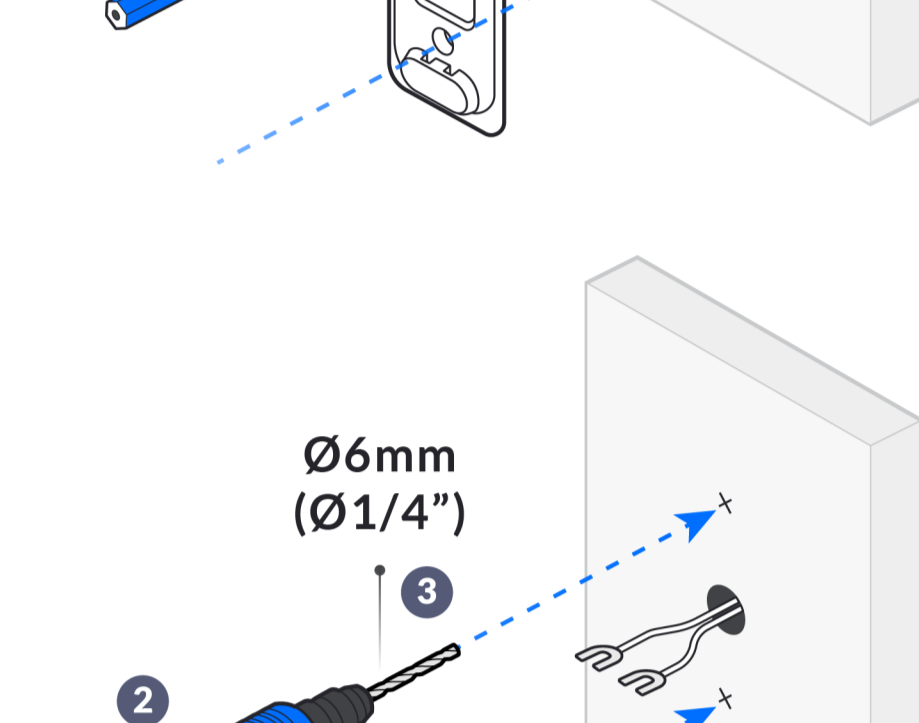

B

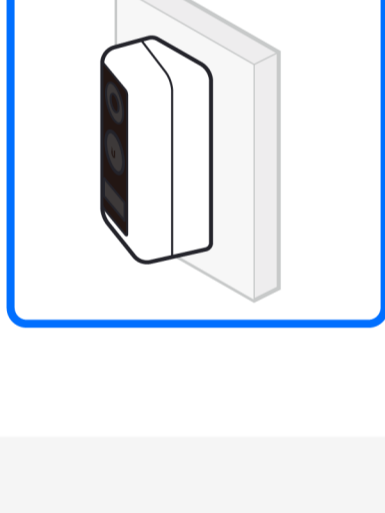

- 1 Pencil
- 2 Power drill
- 3 $\text{\O}6\text{mm}$ ($\text{\O}1/4''$) drill bit
- 4 Screwdriver
- 5 Hammer

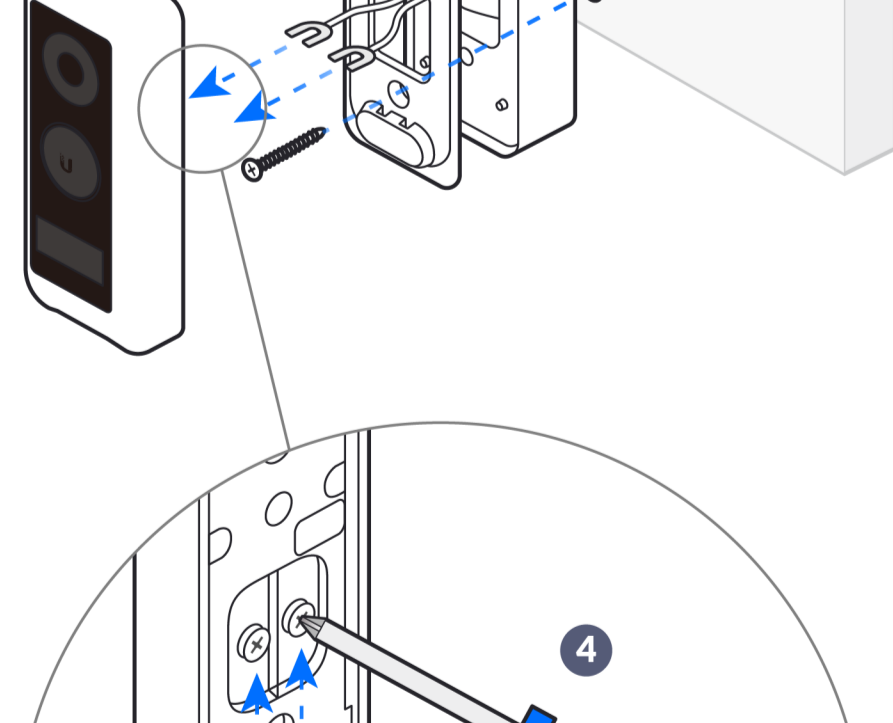
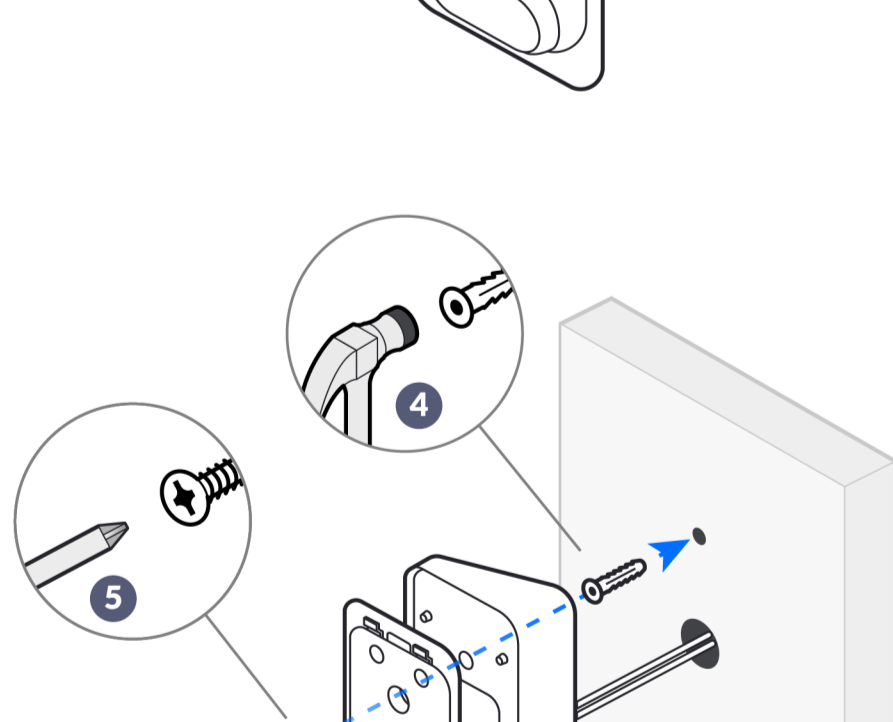
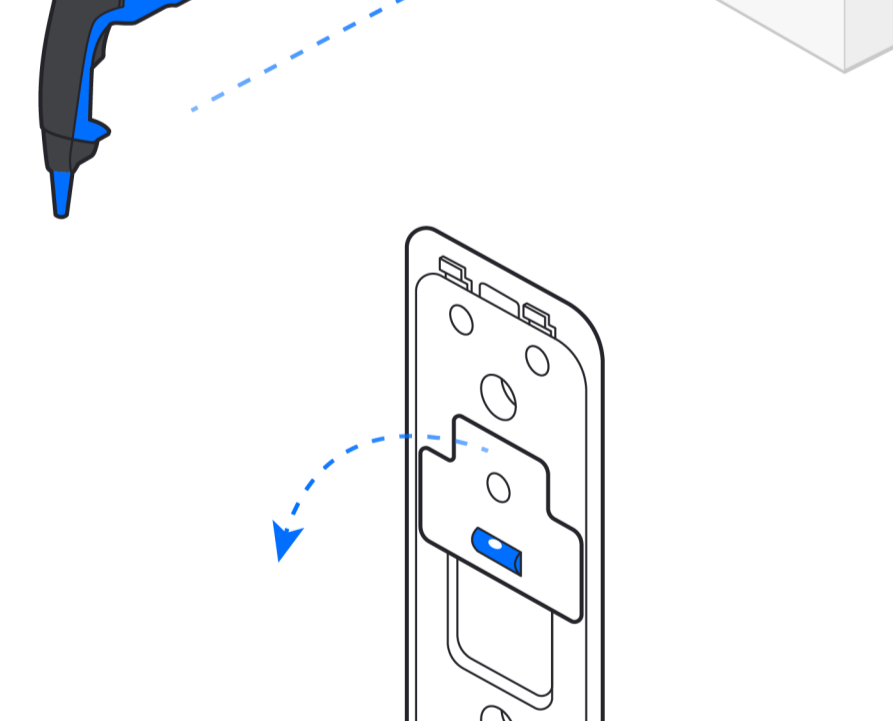
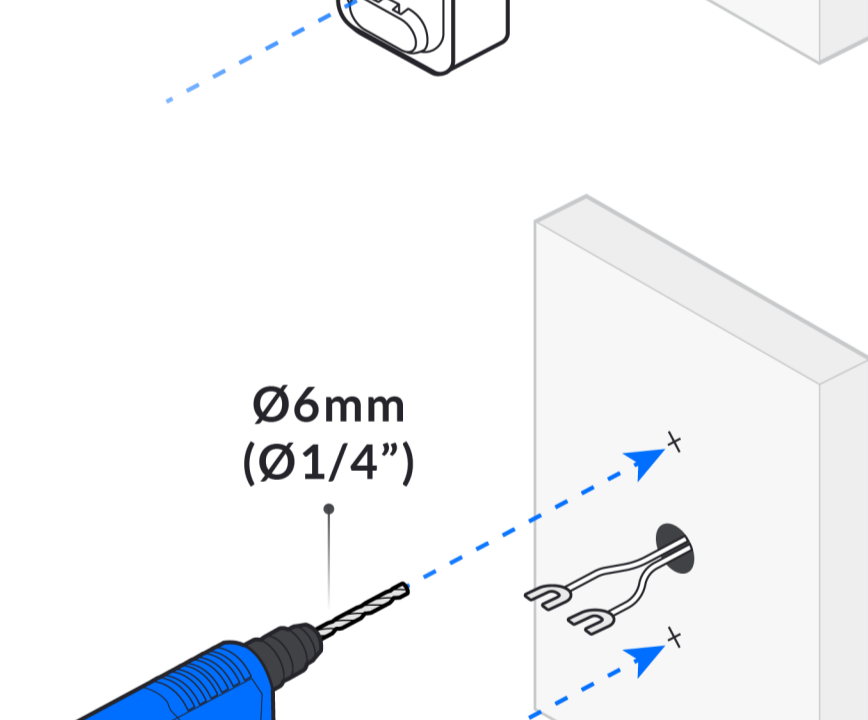
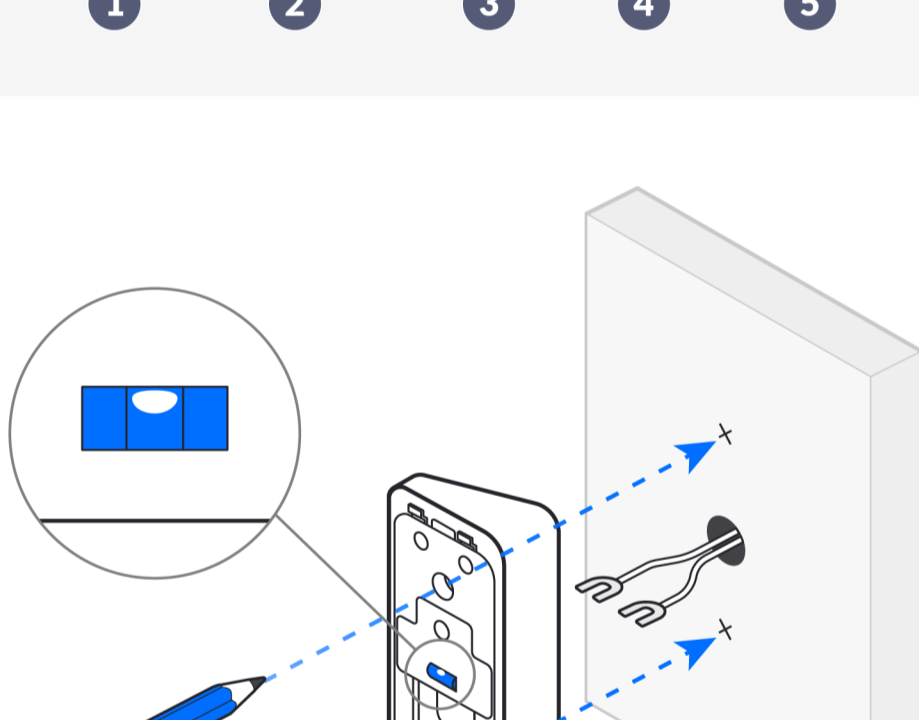

3

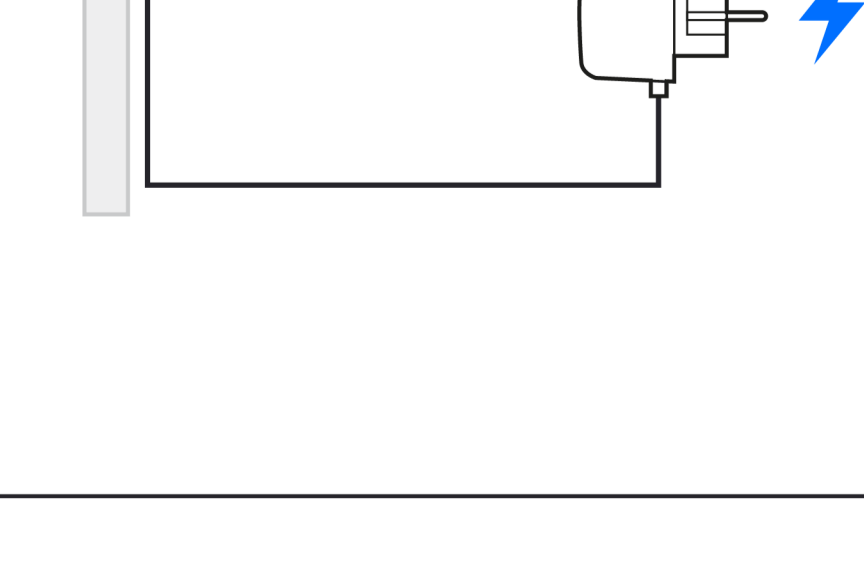

Get Answers
help.ui.com

UI Support

